

FSN

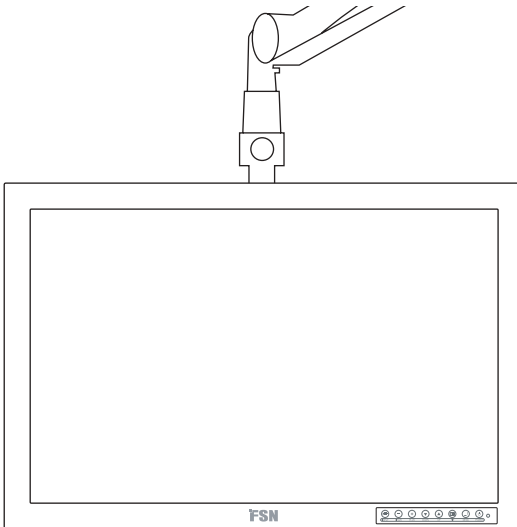

MEDICAL LCD MONITOR

USER'S GUIDE

Before connecting, operating or adjusting this product, please read this instruction booklet carefully and completely.

Rev. 4.0, August 20113

MEDICAL LCD MONITOR

FS-L190*D (19")

FS-L190*DT(19")

FS-L240*D (24")

FS-L240*DT(24")

FS-L260*D (26")

FS-P260*D (26")

FS-L320*D (32")

FS-L420*D (42")

FS-L550*D (55")

Model definition

F S- L XXX * D T

1 2 3 4 5 6

1. FS : Monitor manufacturer.
2. L : Panel manufacturer.
3. XXX : Display size.
4. * : Signal input option.
5. D : Medical grade.
6. T : Touch screen installed.

Table of Contents

Symbol Definitions	3
Safety Instructions	5
Caution.....	8
FCC Information	11
Parts	
• FS-L190*D / FS-L190*DT	16
• FS-L240*D / FS-L240*DT	17
• FS-L260*D / FS-P260*DT	18
• FS-L320*D	19
• FS-L420*D / FS-L550*D	20
Connector	
• FS-L190*D / FS-L240*D / FS-L260*D / FS-P260*D / FS-L320*D	21
• FS-L190*DT / FS-L240*DT / FS-P260*DT	22
• FS-L420*D / FS-L550*D	23
Mechanical Product Drawing	
• FS-L190*D / FS-L190*DT	24
• FS-L240*D / FS-L240*DT	25
• FS-L260*D	26
• FS-L260*D(LED) / FS-P260*D(LED)	27
• FS-L320*D	28
• FS-L420*D	29
• FS-L550*D	30
Control	31
Power management	35
OSD	36
Standard Signal table	51
Signam connector Pin Assignments	52
Specification	55
Cleaning instructions	63
DVI ② (Fiber) install guide (Rx)	66

Symbol Definitions

The following symbols appear on the product, its labels, or the product package.
Each symbol carries a special definition, as defined below.



Dangerous : High Voltage.



Consult accompanying documents.



Direct Current.



Power adaptor.



Indicates protective earth ground.



Indicates equipotential earth ground.



DC Power control switch.



Top-Bottom.



Fragile.



Do not get wet.



Maximum Stacking.(19"/24"/26")



Consult the operating instructions.



Maximum Stacking.(32"/42"/55")



Indicates the manufacturing date.



Manufacturer.



Representative in the USA.



Serial Number.



Authorised representative in the European community.

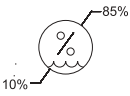

Humidity limitation.

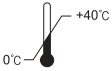

Temperature limitation.

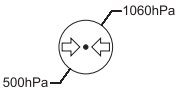

Atmospheric pressure limitation.



Indicates proof of conformity to applicable European Economic Community Council directives and to harmonized standards published in the official journal of the European Communities.



Medical LCD monitor is in accordance with UL 60601-1 and CAN/CSA C22.2 No.601.1 in regards to electric shock, fire hazards, and mechanical hazard.



Tested to comply with FCC Class B standard.



Indicates the display is approved according to the CCC regulations.



China RoHS labels.



This symbol indicates that the waste of medical LCD monitor must not be disposed as unsorted municipal waste and must be collected separately. Please contact the manufacturer or other authorized disposal company to decommission your medical LCD monitor.

Language: English

Note: A printed copy of the manual in English is provided with the product. Users within EU member state, please contact local distributor or Foreseeson Custom Displays, Inc. for other languages or refer to the CD manual enclosed with the product. This applies to EU member state where the product has been purchased through authorized channels.

Safety Instructions

On Safety

1. Before connecting the AC power cord to the DC adapter outlet make sure the voltage designation of the DC adapter corresponds to the local electrical supply.
2. Never insert anything metallic into the cabinet openings of the medical LCD monitor. Doing so may create the danger of electric shock.
3. To reduce the risk of electric shock, do not remove cover.
No user-serviceable parts inside. Only a qualified technician should open the case of the medical LCD monitor.
4. Never use your medical LCD monitor if the power cord has been damaged.
Do not allow anything to rest on the power cord, and keep the cord away from areas where people can trip over it.
5. Be sure to hold the plug, not the cord, when disconnecting the medical LCD monitor power cord from an electric socket.
6. Unplug your medical LCD monitor power cord when it is going to be left unused for an extended period of time.
7. Unplug your medical LCD monitor power cord from the AC outlet before any service.
8. If your medical LCD monitor does not operate normally, in particular, if there are any unusual sounds or smells coming from it, unplug it immediately and contact an authorized dealer or service center.
9. Please contact the manufacturer if the set should be installed in an inaccessible area.

Warning

Do not touch input or output connectors and the patient simultaneously.

Warning

This medical LCD monitor is intended for connection to input/output signals and other connectors that comply with relevant IEC standard (e.g., IEC60950 for IT equipment and IEC60601 series for medical electrical equipment).

In addition, all such combination-system shall comply with the standard IEC 60601-1-1, safety requirements for medical electrical systems. Any person who has formed a combination-system is responsible for the system to comply with the requirements of IEC 60601-1-1.

If in doubt, contact qualified technician or your local representative.

On installation

1. Openings in the medical LCD monitor cabinet are provided for ventilation. To prevent overheating, these openings should not be blocked or covered. If you put the medical LCD monitor in a bookcase or some other enclosed space, be sure to provide adequate ventilation.
2. Put your medical LCD monitor in a location with low humidity and a minimum of dust.
3. Do not expose the medical LCD monitor to rain or use it near water (in kitchens, near swimming pools, etc.). If the medical LCD monitor accidentally gets wet, unplug it and contact an authorized dealer immediately. You can clean the medical LCD monitor with a damp cloth if necessary, but be sure to unplug the medical LCD monitor first.
4. Place your medical LCD monitor near an easily accessible AC outlet.
5. High temperature can cause problems. Don't use your medical LCD monitor in direct sunlight and keep it away from heaters, stoves, fireplaces, and sources of heat.
6. Don't place your medical LCD Monitor on an unstable stand, Medical LCD monitor may malfunction or fall.
7. This medical LCD monitor should not topple over when tilted at a 5° angle, in any position, during NORMAL USE, excluding transport.
8. In the position specified for transport, medical LCD monitor shall not overbalance when tilted at a 10 degree angle.
9. When you carry this product, please use both handles on left and right side of the product which carrying more two persons.
If you want the product to be installed on another place, please call A/S center.

10. Do not use other cable or accessory that are not provided.
11. Do not lay this monitor on the other equipment.

Environmental Conditions for operation and Storage

- Temperature range within 0°C to 40°C(operation), -20°C to 60°C(storage)
- Relative humidity range 10% to 85%
- Atmospheric pressure range within 500 to 1060hPa.

Intended Use

- This Medical LCD Monitor is an accessory intended for use with Medical Equipment to display alphabetical, numerical and graphical data.

CAUTION



This symbol alerts the user that important literature concerning the operation of this unit has been included. Therefore, it should be read carefully in order to avoid potential problems.



This symbol warns user that un-insulated voltage within the unit may have sufficient magnitude to cause electrical shock. Therefore, it is dangerous to make contact with any part inside the unit. To reduce the risk of electric shock, DO NOT remove cover (or back). There are no user serviceable parts inside. Refer servicing to qualified service personnel.

To prevent fire or shock hazards, do not expose this unit to rain or moisture. Also, do not use this unit's polarized plug with an extension cord receptacle or other outlets unless the prongs can be fully inserted. The display is designed to meet the medical safety requirements for a patient vicinity device.

This device may not be used in connection with life support equipment.



Underwriters Laboratories (UL) Classification:

UL safety Compliance:

This medical LCD monitor is U.L. Classified WITH RESPECT TO ELECTRIC SHOCK, FIRE AND MECHANICAL HAZARDS ONLY IN ACCORDANCE WITH UL 60601-1/CAN/CSA C22.2 NO. 601.1



EEC Safety Compliance

This medical LCD monitor unit meets the requirements of EN-60601-1 so as to conform to the Medical Device Directive 93/42/EEC (general safety information).

Use 120V rating 5-15P type plug only in the U.S

This medical LCD monitor complies to the above standards only when used with the supplied medical grade power supply.

19"(FS-L190*D / FS-L190*DT) - JMW190KA1200F02(BRIDGE POWER CORP.)

24"/26"(FS-L240*D / FS-L240*DT / FS-L260*D)

JMW1150KA2400F04(BRIDGE POWER CORP.)

26"LED (FS-P260*D / FS-L260*D) - BPM150S24F10(BRIDGE POWER CORP.)

32"(FS-L320*D) -JMW1180KA2400F01(BRIDGE POWER CORP.)

Caution: Make sure the power cord is the correct type that is required in your area. This medical LCD monitor has a universal power supply that allows operation in either 100-120V AC or 200-240V AC voltage areas (no user adjustment is required).

Use the proper power cord with correct attachment plug type. If the power source is 120 V AC, use a power cord which is a Hospital Grade Power Cord with NEMA 5-15 style plug, labeled for 125 volts AC with UL and C-UL approvals. If the power source is a 240 V AC supply, use the tandem (T blade) type attachment plug with ground conductor power cord that meets the respective European country's safety regulations.

The hospital-grade plug for medical products intended for use in Denmark has DEMKO approval and is rated 13 amps at 250Vac. Plug is recommended for use in medical applications and specifications are being added to the standard SB 107-2-D1. Plug mates with maker's Danish hospital-grade socket. Hospital sockets have slightly different shaped openings allowing only the hospital plug, not the standard Danish plug, to be inserted, to protect the ac circuit in specific medical settings.

A ground post, located on the back of the display, may be used for the purpose of grounding the display's chassis. Any such ground must be installed in accordance with applicable electrical codes. The groundpost is shown on the mechanical drawing found on page 20~22.

Recycling



Follow local governing ordinances and recycling plans regarding the recycling or disposal of this equipment.

Cleaning Instructions



Follow your hospital protocol for the handling of blood and body fluids. Clean the display with a diluted mixture of mild detergent and water. Use a soft towel or swab.

Use of certain detergents may cause degradation to the labels and plastic components of the product.

Consult cleanser manufacturer to see if agent is compatible.

Do not allow liquid to enter the display.

Servicing

Do not attempt to service the medical LCD monitor yourself, as opening or removing covers may expose you to dangerous voltages or other hazards, and will void the warranty. Refer all servicing to qualified service personnel.

Unplug the medical LCD monitor from its power source and refer servicing to qualified personnel under the following conditions:

- If the power cord or plug is damaged or frayed.
- If liquid has been spilled into the medical LCD monitor.
- If objects have fallen into the medical LCD monitor.
- If the medical LCD monitor has been exposed to rain or moisture.
- If the medical LCD monitor has been subjected to excessive shock by being dropped.
- If the cabinet has been damaged.
- If the medical LCD monitor seems to be overheated.
- If the medical LCD monitor emits smoke or abnormal odor.
- If the medical LCD monitor fails to operate in accordance with the operating instructions.

Accessories

Use only accessories specified by the manufacturer, or sold with the medical LCD monitor.

Classification

- Protection against electric shock : Class I including AC/DC Adapter
- Applied Parts : No Applied Parts
- Degree of safety in the presence of flammable anesthetics mixture with air or with oxygen or with nitrous oxide.
Not suitable for use in the presence of a flammable anesthetics mixture with oxygen or with nitrous oxide.
- Mode of operation : Continuous.

FCC Information

This medical LCD monitor unit has been tested and found to comply with the limits of a Class B digital device, pursuant to Part 15 of the FCC rules. These limits are designed to provide reasonable protection against interference. This monitor can radiate radio frequency energy and, if not installed and used in accordance with the instructions, it may interfere with other radio communications equipment. There is no guarantee that interference will not occur in a particular installation.

If this equipment is found to cause harmful interference to radio or television reception, the user is encouraged to try to correct the interference by carrying out one or more of the following measures:

1. Reorient or relocate the receiving antenna.
2. Increase the distance between the medical LCD monitor and the subject of interference.
3. Plug the monitor into an outlet on a different electrical circuit than that to which the subject of interference is connected.
4. Consult the dealer or an experienced radio/TV technician for help.

NOTICES TO USER

This device complies with part 15 of the FCC Rules. Operation is subject to the following two conditions:

(1) this device may not cause harmful interference, and (2) this device must accept any interference received, including interference that may cause undesired operation.

FCC WARNING

This medical LCD monitor generates or uses radio frequency energy. Changes or modifications to this medical LCD monitor may cause harmful interference unless the modifications are expressly approved in the instruction manual. The user could lose authority to operate this equipment if an unauthorized change or modification is made.

1. Guidance and manufacturer's declaration - electromagnetic emissions

<p>The medical LCD monitor is intended for use in the electromagnetic environment specified below. The customer or the user of the medical LCD monitor should assure that it is used in such an environment.</p>		
Emission test	Compliance	Electromagnetic environment -guidance
RF Emissions CISPR 11	Group 1	<p>The medical LCD monitor is suitable for use in all establishments, including domestic establishments and those directly connected to the public low-voltage power supply network that supplies buildings used for domestic purposes</p>
RF Emissions CISPR 11	Class B	
Harmonic emissions IEC 61000-3-2	D	
Voltage fluctuations IEC 61000-3-3	Complies	

2. Guidance and manufacturer's declaration - electromagnetic immunity

<p>This medical LCD monitor is intended for use in the electromagnetic environment specified below. The customer or the user of the medical LCD monitor should assure that it is used in such an environment.</p>			
Immunity test	IEC 60601 Test level	Compliance level	Electromagnetic environment -guidance
Electrostatic discharge(ESD) IEC61000-4-2	6kV Contact 8kV air	6kV Contact 8kV air	Floors should be wood,concrete or ceramic tile. If floors are covered with synthetic material, the relative humidity should be at least 30%
Electrical fast transient/burst IEC 61000-4-4	2kV for power supply lines 1kV for input/output lines	2kV for power supply lines 1kV for input/output lines	Mains power quality should be that of a typical commercial or hospital environment.

Surge IEC 61000-4-5	1kV differential mode 2kV common mode	1kV differential mode 2kV common mode	Mains power quality should be that of a typical commercial or hospital environment.
Conducted RF IEC 61000-4-6	3 Vrms 150 kHz to 80MHz	3 Vrms 150 kHz to 80MHz	<p>Portable and mobile RF communications equipment should be used no closer to any part of the medical LCD monitor, including cables, than the recommended separation distance calculated from the equation applicable to the frequency of the transmitter.</p> <p>Recommended separation distance : d</p> $d = \left[\frac{3,5}{V_T} \right] \sqrt{P}$ <p>where P is the maximum output power rating of the transmitter in watts (W)</p>

3. Guidance and manufacturer's declaration - electromagnetic immunity

This medical LCD monitor is intended for use in the electromagnetic environment specified below. The customer or the user of monitor should assure that it is used in such an environment.			
Immunity test	IEC 60601 Test level	Compliance level	Electromagnetic environment -guidance
Power frequency (50/60Hz) magnetic field IEC 61000-4-8	3.0A/m	3.0A/m	Power frequency magnetic fields should be at levels characteristic of a typical location in a typical commercial or hospital environment.
Voltage dips, short interruptions and voltage variations on power supply input lines IEC 61000-4-11	<p><5 % UT (>95 % dip in UT) for 0.5 cycle</p> <p>40 % UT (60 % dip in UT) for 5 cycle</p> <p>70 % UT (30 % dip in UT) for 25 cycle</p> <p><5 % UT (<95 % dip in UT) for 5 sec.</p>	<p><5 % UT (>95 % dip in UT) for 0.5 cycle</p> <p>40 % UT (60 % dip in UT) for 5 cycle</p> <p>70 % UT (30 % dip in UT) for 25 cycle</p> <p><5 % UT (<95 % dip in UT) for 5 sec.</p>	<p>Main power quality should be that of a typical commercial or hospital environment. If the user of monitor requires continued operation during power mains interruptions, it is recommended that monitor be powered from an uninterruptible power supply or a battery.</p> <p>NOTE : UT the A.C. mains voltage prior to application of the test level.</p>

Immunity test	IEC 60601 Test level	Compliance level	Electromagnetic environment -guidance
Radiated RF IEC 61000-4-3	3 V/m 80.0 MHz to 2.5 GHz	3 V/m 80.0 MHz to 2.5 GHz	<p>Recommended separation distance</p> <p>80MHz to 800MHz</p> $d = \left[\frac{3,5}{E_1} \right] \sqrt{P}$ <p>80MHz to 2.5GHz</p> $d = \left[\frac{7}{E_1} \right] \sqrt{P}$ <p>where P is the maximum output power rating of the transmitter in watts (W) according to the transmitter manufacturer and d is the recommended separation distance in meters (m).</p> <p>Field strengths from fixed RF transmitters, as determined by an electromagnetic site survey, It should be less than the compliance level in each frequency range.</p>

4. Recommended separation distances between portable and mobile RF communications equipment and this medical LCD monitor.

- The medical LCD monitor is intended for use in an electromagnetic environment in which radiated RF disturbances are controlled.
- The customer or the user of the monitor can help prevent electromagnetic interference by maintaining a minimum distance between portable and mobile RF communications equipment (transmitters) and the medical LCD monitor as recommended below, according to the maximum output power of the communications equipment.

Rated maximum output power of transmitter [W]	Separation distance according to frequency of transmitter[m]		
	150kHz to 80MHz	80MHz to 800MHz	800MHz to 2.5GHz
	$d = \left[\frac{3,5}{V_1} \right] \sqrt{P}$	$d = \left[\frac{3,5}{E_1} \right] \sqrt{P}$	$d = \left[\frac{7}{E_1} \right] \sqrt{P}$
V1=3Vrms	E1=3V/m	E1=3V/m	

0.01	0.116	0.116	0.2333
0.1	0.368	0.3687	0.7378
1	1.166	1.1660	0.2333
10	3.687	3.6872	0.7375
100	11.660	11.6600	23.333

For transmitters rated at a maximum output power not listed above, the recommended separation distance d in meters (m) can be estimated using the equation applicable to the frequency of the transmitter, where p is the maximum output power rating of the transmitter in watts (W) according to the transmitter manufacturer.

NOTE 1) At 80MHz and 800MHz, the separation distance for the higher frequency range applies.

NOTE 2) These guidelines may not apply in all situations. Electromagnetic propagation is affected by absorption and reflection from structures, objects and people.

Parts

▶ 19" FS-L190*D / FS-L190*DT Monitor

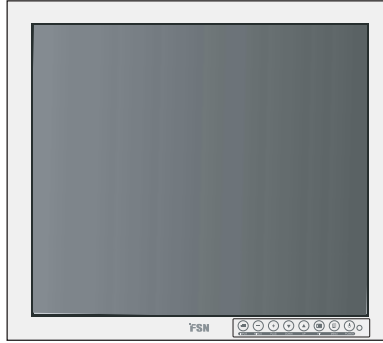

▶ Accessories



User Manual

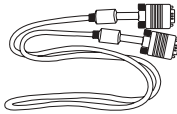

D-SUB Cable
(6ft/1.8m)

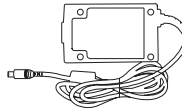

AC-DC Adaptor
(JMW190KA1200F02)

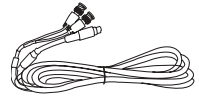

S-Video (Y/C) Cable
(Option)

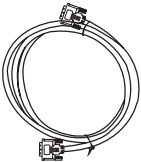

DVI Cable
(6ft/1.8m)

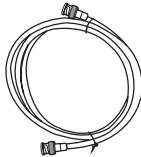

BNC Cable
(6ft/1.8m)

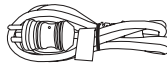

AC Power cord
(6ft/1.8/m US,UK,EU)
(Hospital Grade)

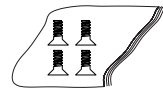

SCREW FH M3X6

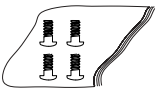

SCREW BH M4X10



(Option)

▶ 24" FS-L240*D / FS-L240*DT Monitor



▶ Accessories



User Manual

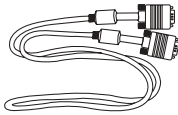

D-SUB Cable
(6ft/1.8m)

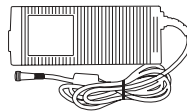

AC-DC Adaptor
(JMW1150KA2400F04)

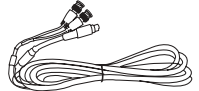

S-Video (Y/C) Cable
(Option)

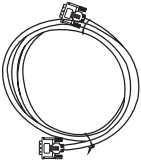

DVI Cable
(6ft/1.8m)

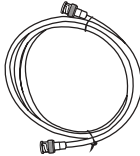

BNC Cable
(6ft/1.8m)

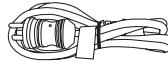

AC Power cord
(6ft/1.8/m US,UK,EU)
(Hospital Grade)

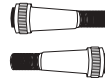

DC Cable Terminal
Male / female (Option)

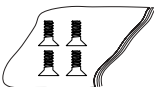

SCREW FH M3X6
17 - English

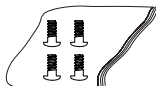

SCREW BH M4X10



(Option)

▶ 26" FS-L260*D / FS-P260*D(LED) Monitor



▶ Accessories



User Manual

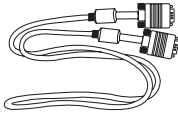

D-SUB Cable
(6ft/1.8m)

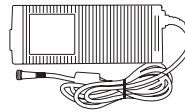

AC-DC Adaptor
(JMW1150KA2400F04)
(BPM150S24F10)

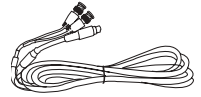

S-Video (Y/C) Cable
(Option)

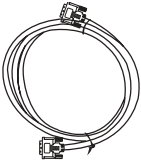

DVI Cable
(6ft/1.8m)

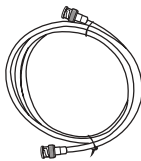

BNC Cable
(6ft/1.8m)

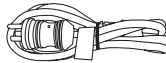

AC Power cord
(6ft/1.8m US,UK,EU)
(Hospital Grade)

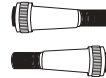

DC Cable Terminal
Male / female (Option)



(Option)

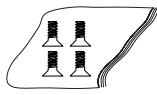

SCREW FH M3X6

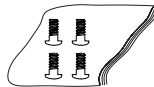

SCREW BH M4X10

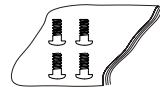

SCREW BHM4X6

▶ 32" FS-L320*D Monitor

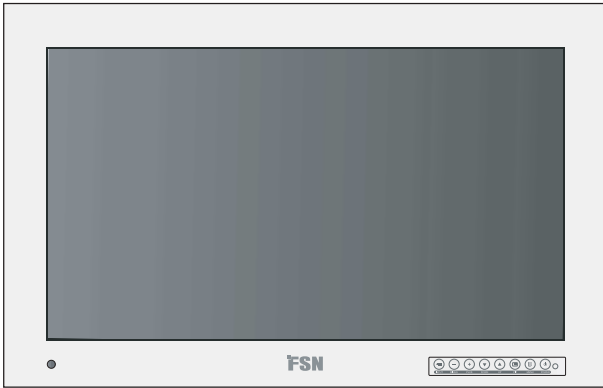

▶ Accessories



User Manual

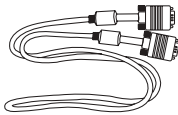

D-SUB Cable
(6ft/1.8m)

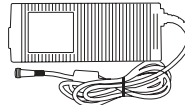

AC-DC Adaptor
(JMW1180KA2400F01)

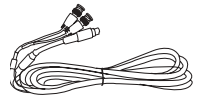

S-Video (Y/C) Cable
(Option)

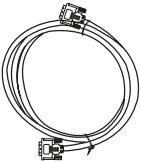

DVI Cable
(6ft/1.8m)

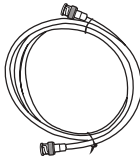

BNC Cable
(6ft/1.8m)

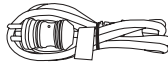

AC Power cord
(6ft/1.8/m US,UK,EU)
(Hospital Grade)

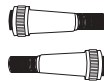

DC Cable Terminal
Male / female (Option)

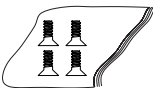

SCREW FH M3X6

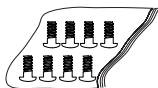

SCREW BH M4X10



Remote controller

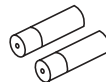

Battery(AAA)

▶ 42" FS-L420*D / 55" FS-L550*D Monitor



▶ Accessories



User Manual

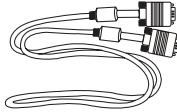

D-SUB Cable
(6ft/1.8m)

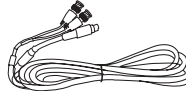

S-Video (Y/C) Cable
(Option)

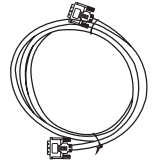

DVI Cable(6ft)

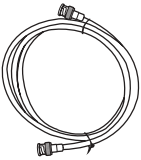

BNC Cable
(6ft/1.8m)

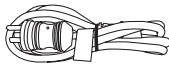

AC Power cord
(6ft/1.8/m US,UK,EU)
(Hospital Grade)

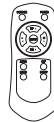

Remote controller

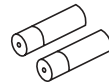

Battery(AAA)

Connector

▶ FS-L190*D / FS-L240*D / FS-L260*D / FS-P260*D / FS-L320*D Input connector



▶ DVI fiber optic(4port LC / 1port SC) input

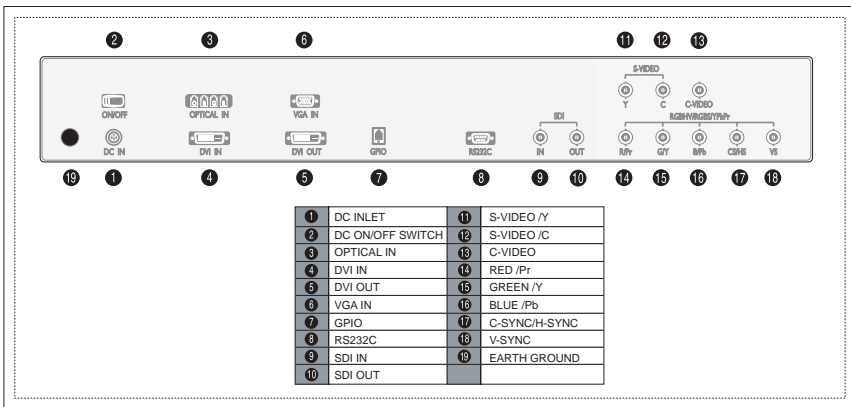

NO. 3 Optical IN do not support on FS-L190*D

▶ Dual DVI input

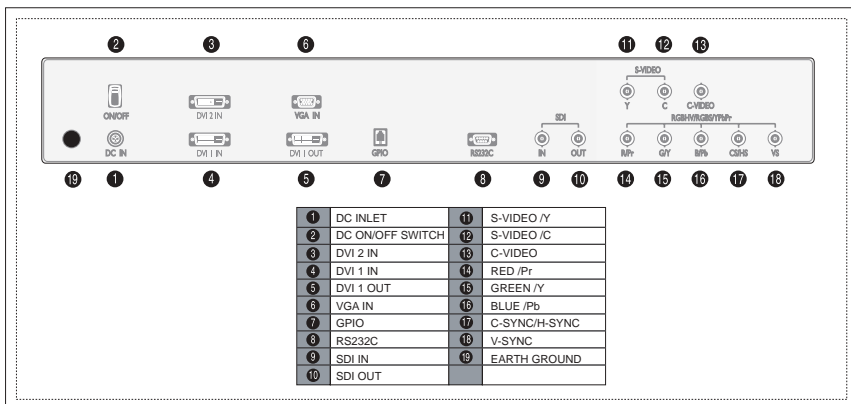

NO. 3 DVI 2 IN do not support on FS-L190*D

FS-L190*DT / FS-L240*DT / FS-P260*DT input connector



► DVI fiber optic(4port LC / 1port SC) input

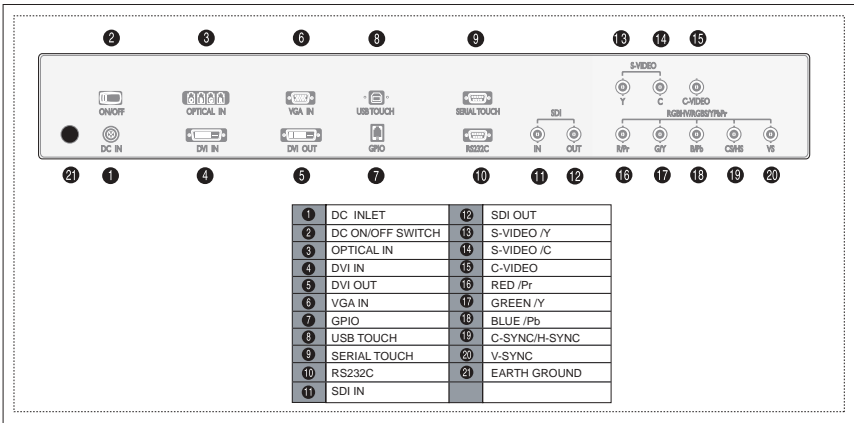

NO. 3 Optical IN do not support on FS-L190*D

► Dual DVI input

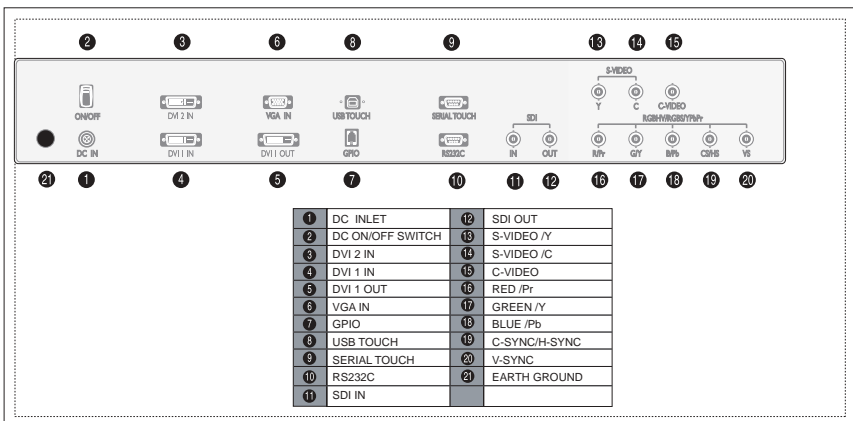

NO. 3 DVI 2 IN do not support on FS-L190*D

FS-L420*D / FS-L550*D Input connector

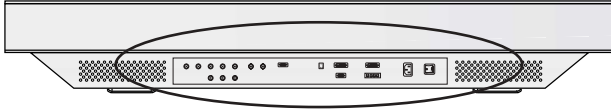

► DVI fiber optic input

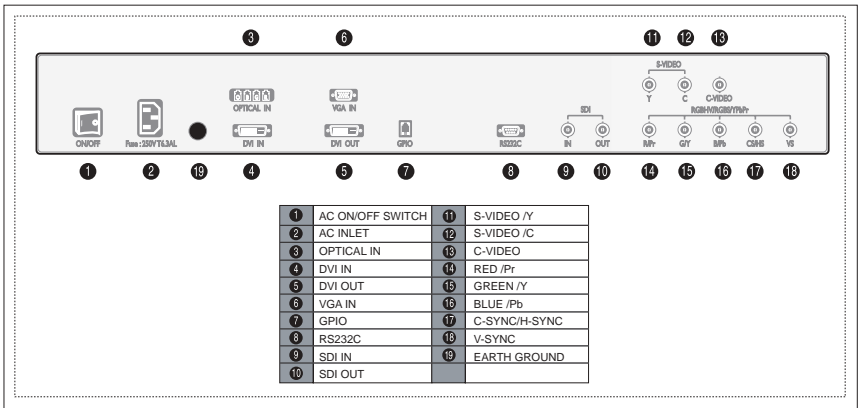

► Dual DVI input

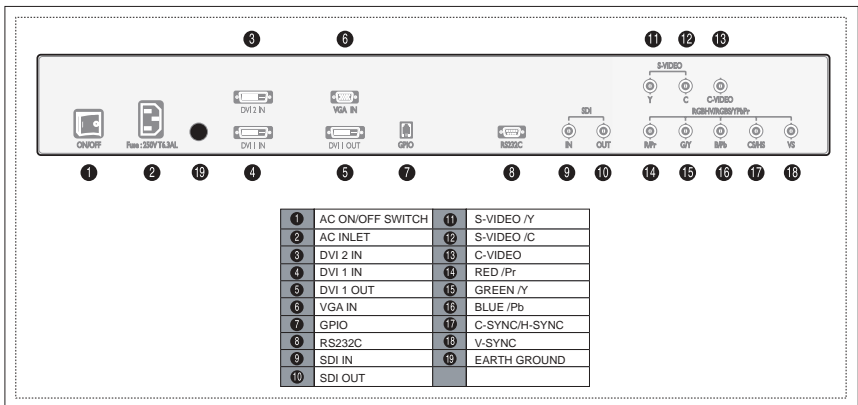

Mechanical Product Drawing

19" FS-L190*D / FS-L190*DT Dimension

Front view

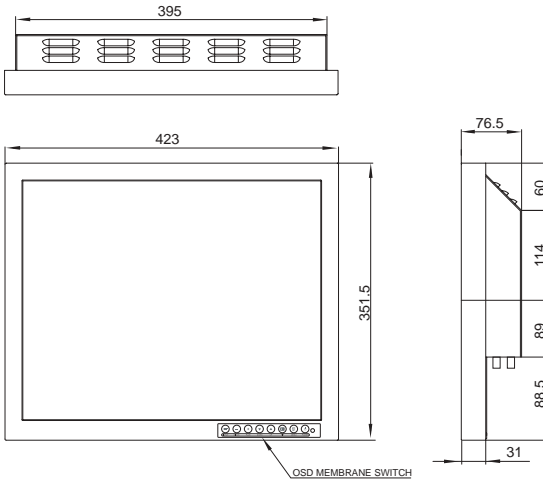

Rear view (Without I/O Cover)

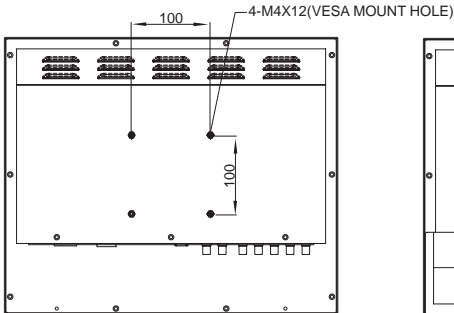

Rear view (Installed I/O Cover)

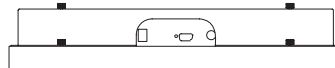
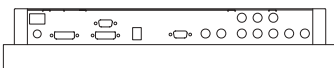
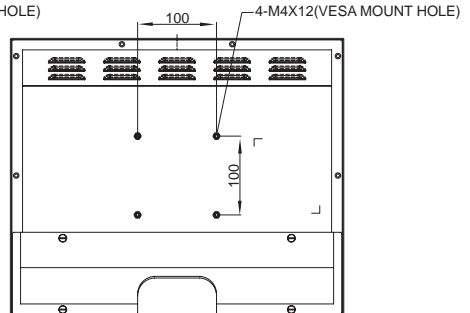

Unit : mm

▶ 24" FS-L240*D / FS-L240*DT Dimension

Front view

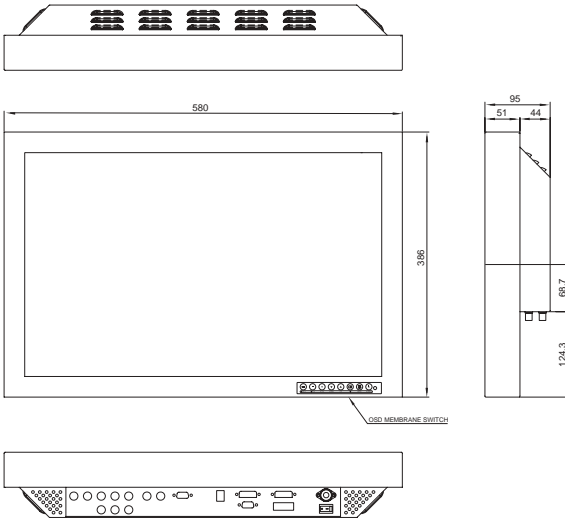

Rear view (Without I/O Cover)

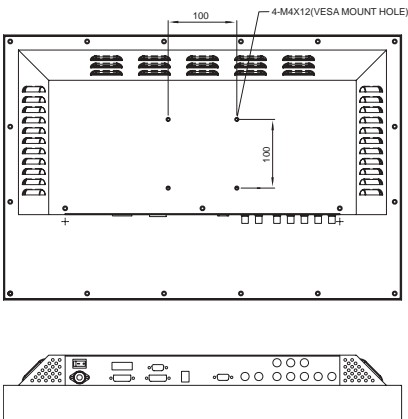

Rear view (Installed I/O Cover)

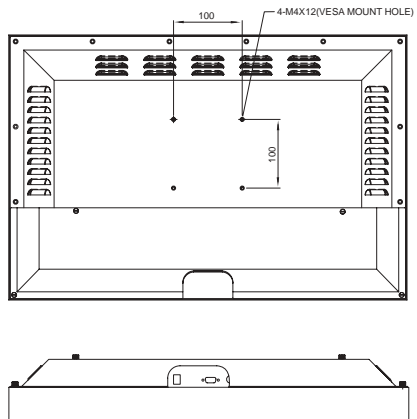

Unit : mm

▶ 26" FS-L260*D Dimension

Front view

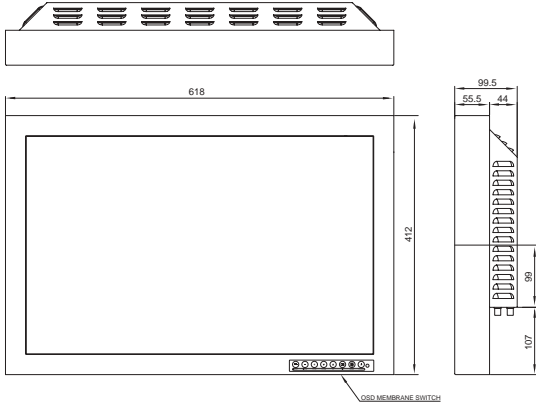

Rear view (Without I/O Cover)

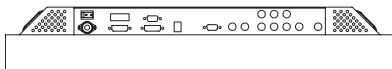
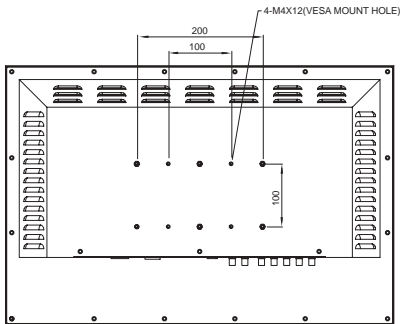

Rear view (Installed I/O Cover)

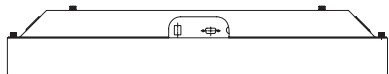
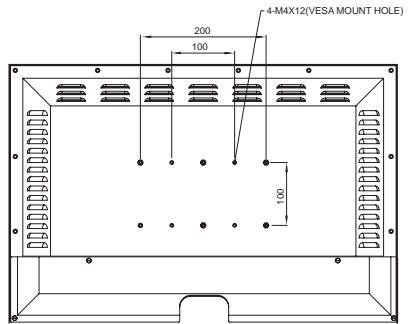

Unit : mm

▶ 26" FS-L260*D(LED) / FS-P260*D(LED) Dimension

Front view

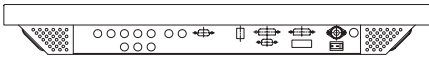
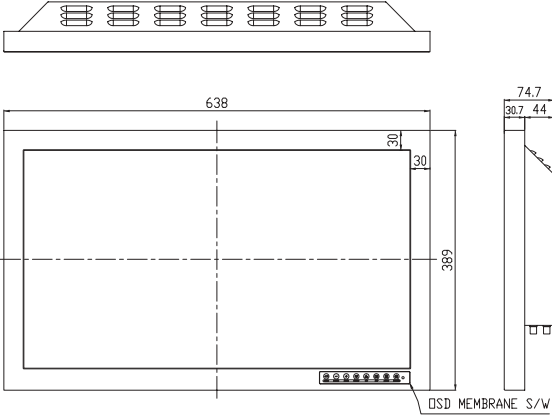

Rear view (Without I/O Cover)

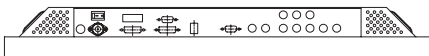
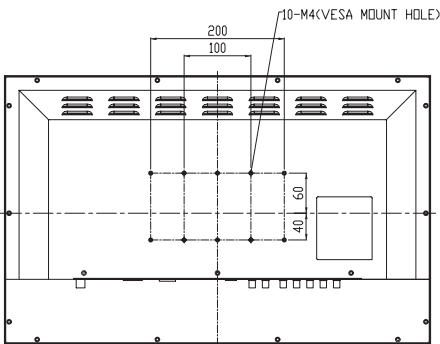

Rear view (Installed I/O Cover)

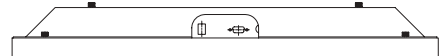
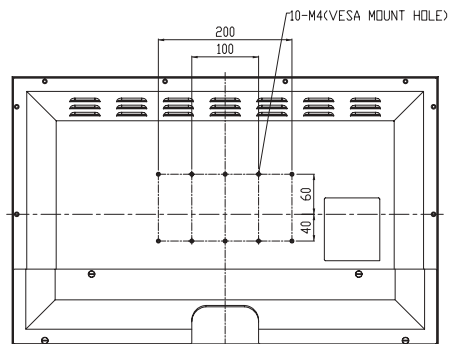

Unit : mm

▶ 32" FS-L320*D Dimension

Front view

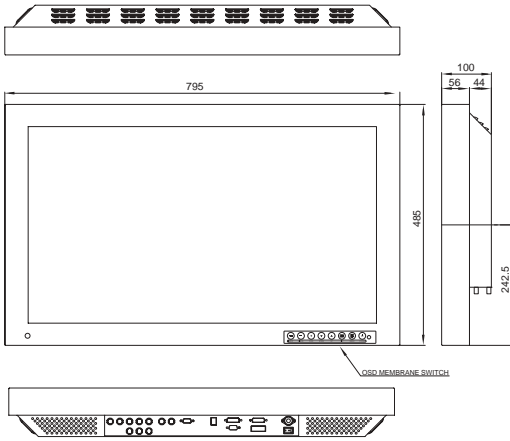

Rear view (Without I/O Cover)

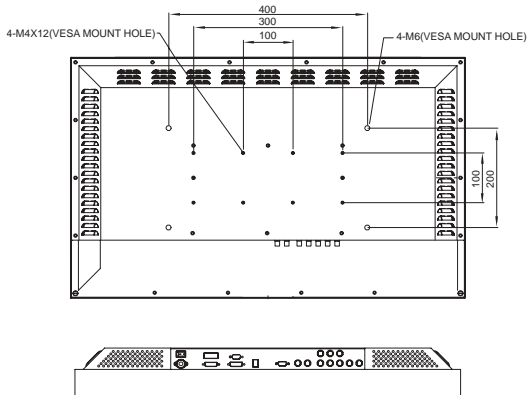

Rear view (Installed I/O Cover)

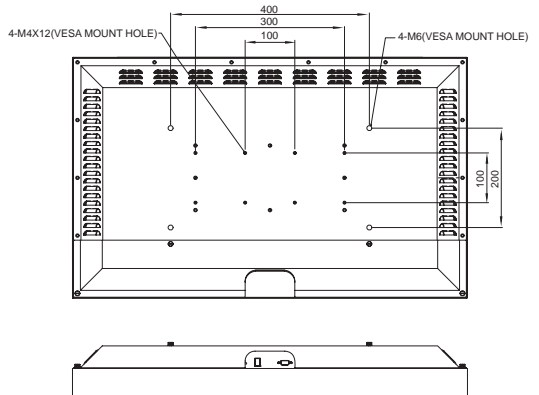

Unit : mm

▶ 42" FS-L420*D Dimension

Front view

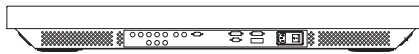
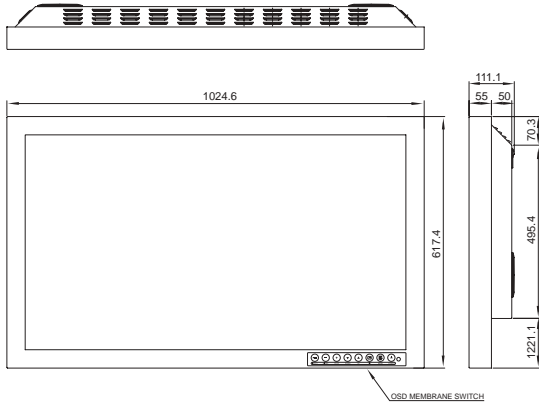

Rear view

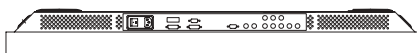
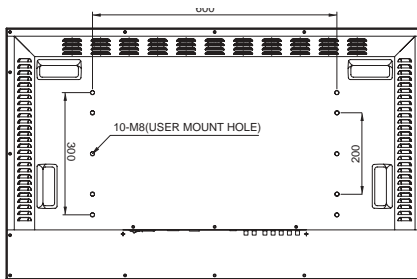

Unit : mm

55" FS-L550*D Dimension

Front view

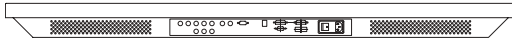
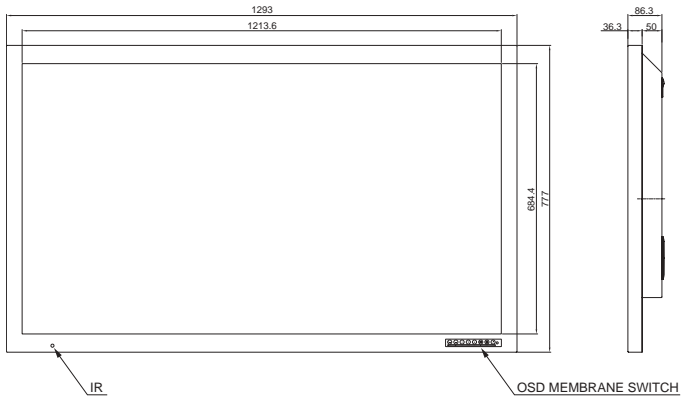

Rear view

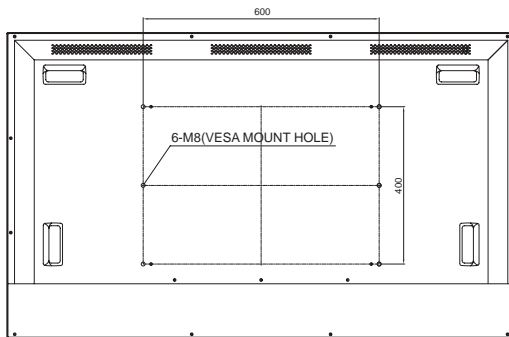

Unit : mm

Control

▶ OSD Button

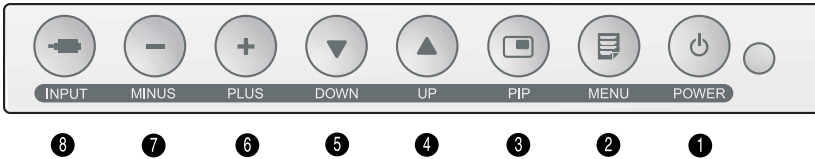

An 8 button keypad, located in bottom right corner on the front of the display, allows the user to make adjustments to various display parameters using the On Screen Display (OSD) system.

● Power Indicating LED

Normal mode (ON): Green

Standby mode : Blinking Green

Off mode : Monitor Off

Note 1 : LED normal and off mode sign can be changed according to the requirement of the customer whether normal mode green is on or off

Note 2 : The main AC power switch, on the back panel, should be in the ON position.
The DC power button is used to turn on the monitor

● On-Screen Display (OSD) Function Button

1. POWER : Soft power turns the monitor ON or OFF
2. MENU : Used to activate to the OSD menu and exit from main menu or sub menu.
3. PIP : Enables PIP (picture in Picture) function.
Selects PIP, PBP1, PBP2.
4. UP (▲) : With the OSD deactivated, it is a Hot Key for increasing brightness.
With the OSD activated, moves the cursor upward.
5. DOWN (▼) : With the OSD deactivated, it is a Hot Key for decreasing brightness.
With the OSD activated, moves the cursor downward.

6. PLUS (+) : With the OSD deactivated, it is a Hot key for increasing contrast.
With the OSD activated, enter sub menu and increases the adjustment of the selected function.
7. MINUS (-) : With the OSD deactivated, it is a Hot key for increasing contrast.
With the OSD activated, it decreases the adjustment of the selected function.
8. INPUT : With the OSD deactivated, if pressed down for over 1 sec., it is a Hot Key for auto-adjustment control under DSUB ANALOG / RGBs signals.
With the OSD activated, it changes the displayed signal source.

▶ Remote button function

<Notice> Remote control is available in FS-L320*D / FS-L420*D / FS-L55*D models only.

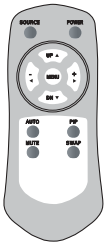
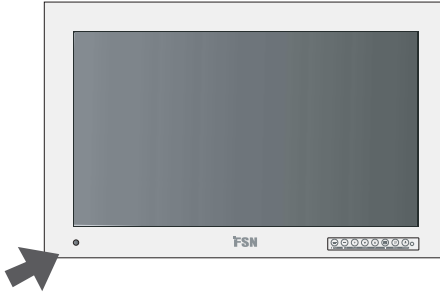

1. SOURCE : Changes the display signal source.
2. POWER : Soft power turns the monitor ON or OFF.
3. UP (▲) : With the OSD deactivated, it is a Hot key for increasing brightness.
With the OSD activated, moves the cursor upward.
4. DOWN (▼) : With the OSD deactivated, it is a Hot key for decreasing brightness.
With the OSD activated, moves the cursor downward.
5. MINUS (-) : With the OSD deactivated, it is a Hot key for decreasing contrast.
With the OSD activated, it decreases the adjustment of the selected function.
6. PLUS (+) : With the OSD deactivated, it is a Hot key for increasing contrast.
With the OSD activated, it increases the adjustment of the Selected function.
7. MENU : With the OSD deactivated, activates the OSD menu.
With the OSD activated, exits from main menu or sub menu.
8. AUTO : Fits to the most appropriate screen on the D-SUB Analog signal.
9. PIP : Enables PIP(picture in Picture) function.
Selects PIP,PBP1,PBP2
10. MUTE : Sound muted.(Not used)
11. SWAP : Swaps the position of the Primary and Secondary images.

GPIO

There are four pins on the RJ9 GPIO connector. Each pin has a preprogrammed function assigned to it. The function is initiated when the pin is grounded.

Pin 1. Primary and Secondary Swap.
Grounding this pin will swap the primary and secondary image.



Pin 3. Record Indicator
The record indicator is displayed in the top left corner when the pin is ground to pin 4. The indicator will vanish when the contact is opened.

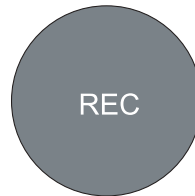

Pin 2. PIP,PBP1,PBP2 Single
Continuously grounding this pin causes the position and size choices to cycle.

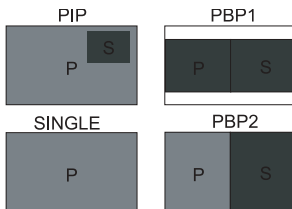

Pin 4. Connector Ground
This is the common ground location.



Power management

This monitor does not adhere to the VESA DPMS standard when no signal is present on the video input.

Model	Status	LED sign	Power Consumption
FS-L190*D	Normal mode	Green on	<60W
	Standby mode	Green blinking	<20W
FS-L190*DT	Normal mode	Green on	<60W
	Standby mode	Green blinking	<20W
FS-L240*D	Normal mode	Green on	<100W
	Standby mode	Green blinking	<20W
FS-L240*DT	Normal mode	Green on	<100W
	Standby mode	Green blinking	<20W
FS-L260*D	Normal mode	Green on	<130W
	Standby mode	Green blinking	<20W
FS-L260*D(LED)	Normal mode	Green on	<70W
	Standby mode	Green blinking	<20W
FS-P260*D(LED)	Normal mode	Green on	<70W
	Standby mode	Green blinking	<20W
FS-L320*D	Normal mode	Green on	<150W
	Standby mode	Green blinking	<20W
FS-L420*D	Normal mode	Green on	<260W
	Standby mode	Green blinking	<20W
FS-L550*D	Normal mode	Green on	<200W
	Standby mode	Green blinking	<20W

DSUB ANALOG / RGBS input source

ADJUST

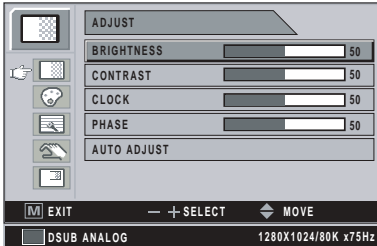

1. BRIGHTNESS
Increases or decreases the brightness. (Range : 0~100)
2. CONTRAST
Increases or decreases the contrast. (Range : 0~100)
3. CLOCK
Increases or decreases the sampling frequency. (Range : 0~100)
4. PHASE
Increases or decreases the Phase level. (Range : 0~100)
5. BACKLIGHT
Adjusts backlight dimming level. (Range : 0~100)
6. AUTO ADJUST
Fits to the most appropriate screen on the D-SUB Analog / RGBs signal.

COLOR TEMP

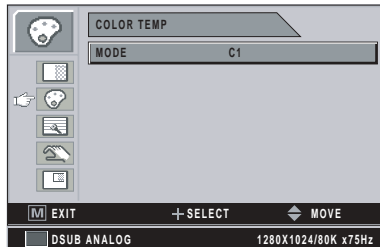

1. MODE
Changes the color mode (C1(Reddish,6500K), C2(Bluish,9300K), USER(7200K))
2. RED
Red balance.(Only works with USER Mode) (Range : 0~100)
3. GREEN
Green balance.(Only works with USER Mode) (Range : 0~100)
4. BLUE
Blue balance.(Only works with USER Mode) (Range : 0~100)

IMAGE

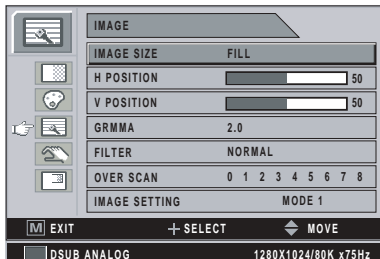

1. IMAGE SIZE
Changes the image size. (Full,Fill aspect,1:1,Normal)
2. H POSITION
Adjusts the horizontal position of the displayed source image.(Range : 0~100)
3. V POSITION
Adjusts the vertical position of the displayed source image. (Range : 0~100)
4. GAMMA
Adjusts GAMMA value (VIDEO,BYPASS,1.8,2.0,2.2,2.4,2.6,PACS)
5. FILTER
Sets the sharpness of image (Softest, Soft, Normal, Sharp, Sharpest)
6. OVER SCAN
Adjusts the displayed size. (0~8)
7. IMAGE SETTING
Changes the image setting.(Preset 1,2 / User 1,2,3)
8. ZOOM / PAN
Enlarges the image, moves images left and right.
9. FREEZE FRAME
Keeps the image still.

SETUP

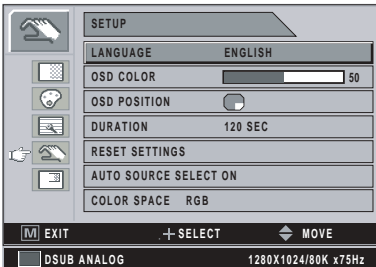

1. LANGUAGE
Changes the OSD language (8 language)
2. OSD COLOR
Adjusts the OSD background from white opaque to translucent.
3. OSD POSITION
Changes the osd position. (9 Positions)
4. DURATION
Adjusts the length of time the OSD menu is present on the screen.
(5, 10, 20, 30, 60, 90, 120, 180, 240 seconds)
5. RESET SETTING
Changes all the OSD values make to factory default.
6. AUTO SOURCE SELECT
Disables or enable auto source select.
ON: Searches through all possible input source until an active video source is found.
OFF: Video input is manually selected.
7. INACTIVE INPUT
Changes the input source between RGBs and YPbPr.
8. PICTURE DELAY
Changes the interace mode setting. (0 : OFF, 1 : ON)

PIP

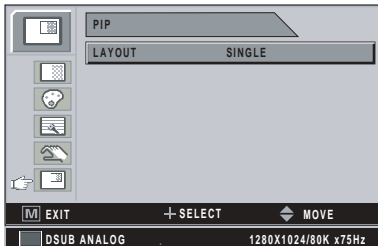

1. LAYOUT
Changes the OSD layout. (Single, PIP, PBP1, PBP2)
2. SOURCE
Changes the secondary source.
3. SIZE
Changes the PIP size(Small, Large).
4. POSITION
Changes the PIP Position.
5. SWAP
Swaps the position and size of the Primary and Secondary image.

DVI OPTICAL / DVI DIGITAL input source

ADJUST

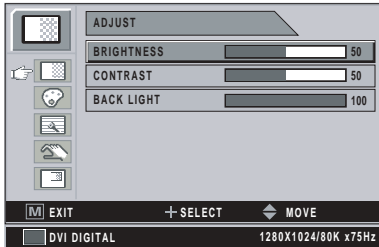

1. BRIGHTNESS
Increases or decrease the brightness. (Range : 0~100)
2. CONTRAST
Increases or decreases the Contrast. (Range : 0~100)
3. BACKLIGHT
Adjusts backlight dimming level. (Range : 0~100)

COLOR TEMP

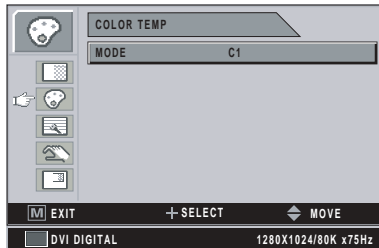

1. MODE
Changes the color temperature mode. (C1(Reddish,6500K), C2(Bluish,9300K), USER(7200K))
2. RED
Red balance. (Only works with USER Mode) (Range : 0~100)
3. GREEN
Green balance. (Only works with USER Mode) (Range : 0~100)
4. BLUE
Blue balance. (Only works with USER Mode) (Range : 0~100)

IMAGE

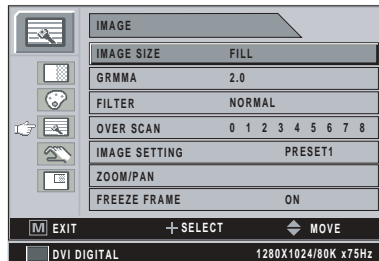

1. IMAGE SIZE
Changes the image size. (Full, Fill aspect**, 1:1**, Norma)
**Only in DVI Optical
2. GAMMA
Adjusts GAMMA value. (VIDEO,BYPASS,1.8,2.0,2.2,2.4,2.6,PACS)
3. FILTER
Sets the sharpness of image. (Softest, Soft, Normal, Sharp, Sharpest)
4. OVER SCAN
Adjusts the displayed size. (0~8)
5. IMAGE SETTING
Changes the image setting. (Preset 1,2 / User 1,2,3)
6. ZOOM/PAN
Enlarges the image, moves images left and right.
7. FREEZE FRAME
Keeps the image still.

SETUP



1. LANGUAGE
Changes the OSD language (8 language)
2. OSD COLOR
Adjusts the OSD background from white opaque to translucent.
3. OSD POSITION
Changes the OSD position. (9 Positions)
4. DURATION
Adjusts the length of time the OSD menu is present on the screen.
(5, 10, 20, 30, 60, 90, 120, 180, 240 seconds)
5. RESET SETTING
Changes all the OSD values to factory outgoing state.
6. AUTO SOURCE SELECT
Disables or enables auto source select.
ON: Searches through all possible input source until an active video source is found.
OFF: Video input is manually selected.
7. INACTIVE INPUT
Changes the input source between RGBs and YPbPr.
8. PICTURE DELAY
Adjust the picture delay.

PIP

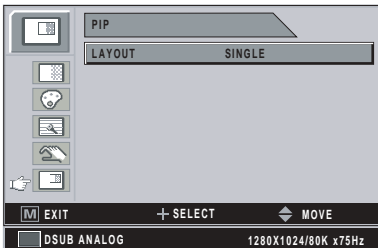

1. LAYOUT
Changes the OSD layout. (Single, PIP, PBP1, PBP2)
2. SOURCE
Changes the secondary source.
3. SIZE
Changes the PIP size (Small, Large).
4. POSITION
Changes the PIP position.
5. SWAP
Swaps the position and size of the Primary and Secondary image.

▶ YPbPr input source

ADJUST

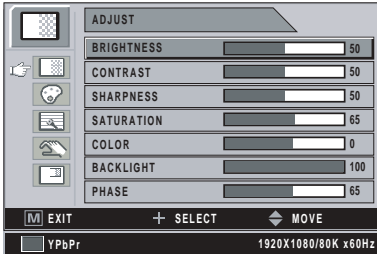

- BRIGHTNESS**
Increases or decreases the brightness. (Range : 0~100)
- CONTRAST**
Increases or decreases the Contrast. (Range : 0~100)
- SHARPNESS**
Adjusts the sharpness of video image. (Range : 0~100)
- SATURATION**
Changes the tone of color. (Range : 0~100)
- COLOR**
Changes the richness of color. (Range : Greenish 0~50, Redish 0~50)
- BACKLIGHT**
Adjusts backlight dimming level. (Range : 0~100)
- CLOCK**
Increases or decreases the sampling. (Range : 0~100)
- PHASE**
Increases or decreases the Phase level. (Range : 0~100)

COLOR TEMP

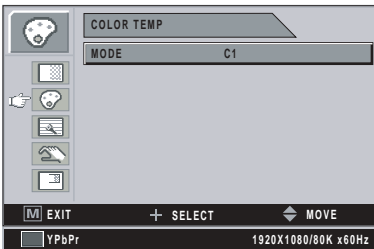

- MODE**
Changes the color temperature mode. (C1(Reddish,6500K), C2(Bluish,9300K), USER(7200K))
- RED**
Red balance. (Only works with USER Mode) (Range : 0~100)
- GREEN**
Green balance. (Only works with USER Mode) (Range : 0~100)
- BLUE**
Blue balance.(Only works with USER Mode) (Range : 0~100)

IMAGE

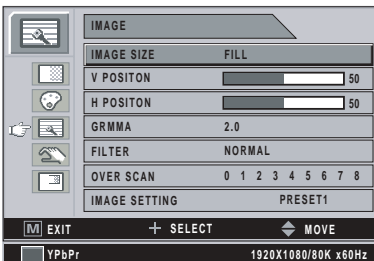

- IMAGE SIZE**
Changes the image size.(Full, Fill aspect, 1:1, Normal, Anamorphic)
- H POSITION**
Adjusts the horizontal position of the displayed source image.(Range : 0~100)
- V POSITION**
Adjusts the vertical position of the displayed source image. (Range : 0~100)
- GAMMA**
Adjusts GAMMA value.(VIDEO,BYPASS,1.8,2.0,2.2,2.4,2.6,PACS))
- FILTER**
Sets the sharpness of image.(Softest, Soft, Normal, Sharp, Sharpest)
- OVER SCAN**
Adjusts the displayed size. (0~8)
- IMAGE SETTING**
Changes the image setting.(Preset 1,2 / User 1,2,3)
- ZOOM / PAN**
Enlarges the image, moves images left and right.
- FREEZE FRAME**
Keeps the image still.

SETUP

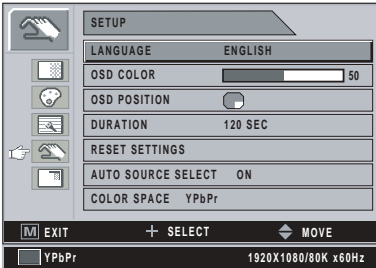

1. LANGUAGE
Changes the OSD language (8 language)
2. OSD COLOR
Adjusts the OSD background from white opaque to translucent.
3. OSD POSITION
Changes the osd position. (9 Positions)
4. DURATION
Adjusts the length of time the OSD menu is present on the screen.
(5, 10, 20, 30, 60, 90, 120, 180, 240 seconds)
5. RESET SETTING
Changes all the OSD values to factory outgoing state.
6. AUTO SOURCE SELECT
Disables or enables auto source select.
ON: Searches through all possible input source until an active video source is found.
OFF: Video input is manually selected.
7. INACTIVE INPUT
Changes the input source between RGBs and YPbPr.
8. PICTURE DELAY
Changes the interace mode setting. (0 : OFF, 1 : ON)

PIP

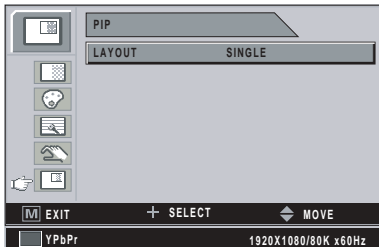

1. LAYOUT
Changes the OSD layout. (Single, PIP, PBP1, PBP2)
2. SOURCE
Changes the secondary source.
3. SIZE
Changes the PIP size(Small, Large).
4. POSITION
Changes the PIP Position.
5. SWAP
Swaps the position and size of the Primary and Secondary image.

VIDEO / CVIDEO input source

ADJUST

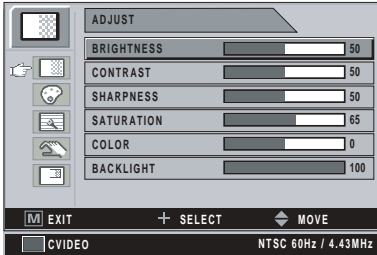

- 1. BRIGHTNESS**
Increases or decreases the brightness. (Range : 0~100)
- 2. CONTRAST**
Increases or decreases the Contrast. (Range : 0~100)
- 3. SHARPNESS**
Adjusts the sharpness of video image. (Range : 0~100)
- 4. SATURATION**
Changes the tone of color. (Range : 0~100)
- 5. COLOR**
Changes the richness of color. (Range : Greenish 0~50, Redish 0~50)
- 6. BACKLIGHT**
Adjusts backlight dimming level. (Range : 0~100)

COLOR TEMP

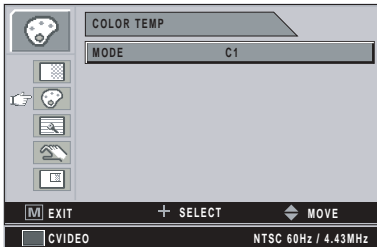

- 1. MODE**
Changes the color temperature mode. (C1(Reddish,6500K), C2(Bluish,9300K), USER(7200K))
- 2. RED**
Red balance.(Only works with USER Mode) (Range : 0~100)
- 3. GREEN**
Green balance.(Only works with USER Mode) (Range : 0~100)
- 4. BLUE**
Blue balance.(Only works with USER Mode) (Range : 0~100)

IMAGE

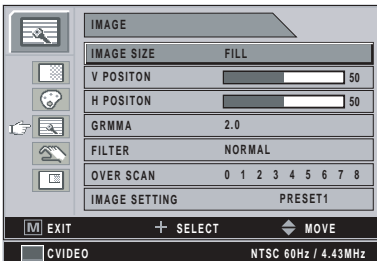

- 1.IMAGE SIZE**
Changes the image size.(Full, Fill aspect, 1:1, Normal, Anamorphic)
- 2. H POSITION**
Adjusts the horizontal position of the displayed source image.(Range : 0~100)
- 3. V POSITION**
Adjusts the vertical position of the displayed source image. (Range : 0~100)
- 4. GAMMA**
Adjusts GAMMA value (VIDEO,BYPASS,1.8,2.0,2.2,2.4,2.6,PACS)
- 5. FILTER**
Sets the sharpness of image (Softest, Soft, Normal, Sharp, Sharpest)
- 6. OVER SCAN**
Adjusts the displayed size. (0~8)
- 7. IMAGE SETTING**
Changes the image setting.(Preset 1,2 / User 1,2,3)
- 8. ZOOM / PAN**
Enlarges the image, moves images left and right.
- 9. FREEZE FRAME**
Keeps the image still.

SETUP



1. LANGUAGE
Changes the OSD language (8 language)
2. OSD COLOR
Adjusts the OSD background from white opaque to translucent.
3. OSD POSITION
Changes the osd position. (9 Positions)
4. DURATION
Adjusts the length of time the OSD menu is present on the screen.
(5, 10, 20, 30, 60, 90, 120, 180, 240 seconds)
5. RESET SETTING
Changes all the OSD values to factory outgoing state.
6. AUTO SOURCE SELECT
Disables or enables auto source select.
ON: Searches through all possible input source until an active video source is found.
OFF: Video input is manually selected.
7. INACTIVE INPUT
Changes the input source between RGBs and YPbPr.
8. PICTURE DELAY
Adjust the picture delay.

PIP

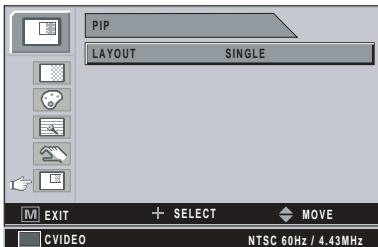

1. LAYOUT
Changes the OSD layout. (Single, PIP, PBP1, PBP2)
2. SOURCE
Changes the secondary source.
3. SIZE
Changes the PIP size(Small, Large).
4. POSITION
Changes the PIP Position.
5. SWAP
Swaps the position and size of the Primary and Secondary image.

SDI input source

ADJUST

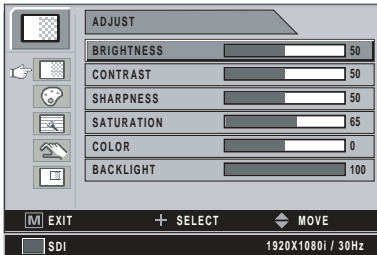

1. BRIGHTNESS
Increases or decreases the brightness. (Range : 0~100)
2. CONTRAST
Increases or decreases the Contrast. (Range : 0~100)
3. SHARPNESS
Adjusts the sharpness of video image. (Range : 0~100)
4. SATURATION
Changes the tone of color. (Range : 0~100)
5. COLOR
Changes the richness of color. (Range : Greenish 0~50, Redish 0~50)
6. BACKLIGHT
Adjusts backlight dimming level. (Range : 0~100)

COLOR TEMP

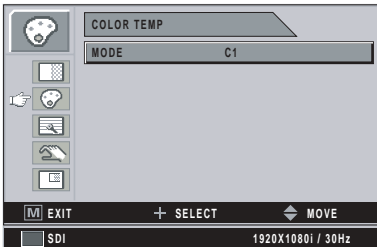

1. MODE
Changes the color temperature mode. (C1(Reddish,6500K), C2(Bluish,9300K), USER(7200K))
2. RED
Red balance.(Only works with USER Mode) (Range : 0~100)
3. GREEN
Green balance.(Only works with USER Mode) (Range : 0~100)
4. BLUE
Blue balance.(Only works with USER Mode) (Range : 0~100)

IMAGE

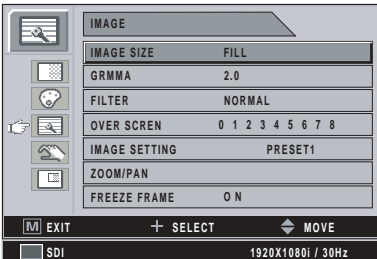

1. IMAGE SIZE
Changes the image size.(Full, Fill aspect, 1:1, Normal, Anamorphic)
2. GAMMA
Adjusts GAMMA value (VIDEO,BYPASS,1.8,2.0,2.2,2.4,2.6,PACS)
3. FILTER
Sets the sharpness of image (Softest, Soft, Normal, Sharp, Sharpest)
4. OVER SCAN
Adjusts the displayed size. (0~8)
5. IMAGE SETTING
Changes the image setting.(Preset 1,2 / User 1,2,3)
6. ZOOM / PAN
Enlarges the image, moves images left and right.
7. FREEZE FRAME
Keeps the image still.

SETUP

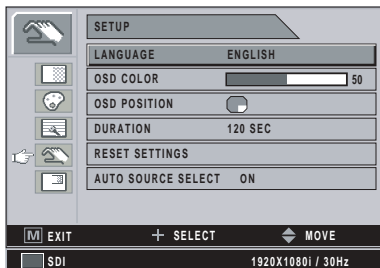





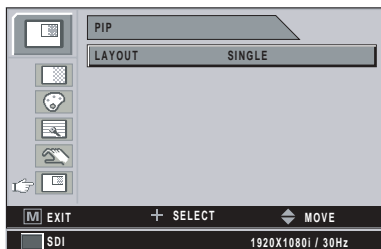



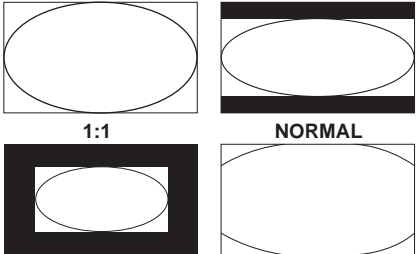
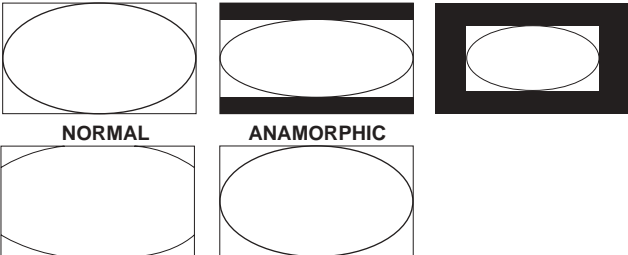

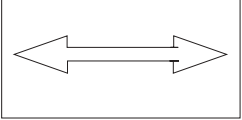
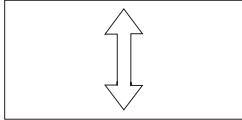
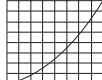
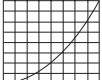
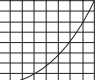
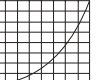
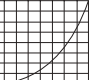
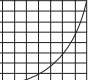
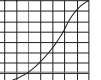

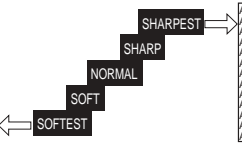
1. LANGUAGE
Changes the OSD language (8 language)
2. OSD COLOR
Adjusts the OSD background from white opaque to translucent.
3. OSD POSITION
Changes the osd position. (9 Positions)
4. DURATION
Adjusts the length of time the OSD menu is present on the screen.
(5, 10, 20, 30, 60, 90, 120, 180, 240 seconds)
5. RESET SETTING
Changes all the OSD values to factory outgoing state.
6. AUTO SOURCE SELECT
Disables or enables auto source select.
ON: Searches through all possible input source until an active video source is found.
OFF: Video input is manually selected.
7. PICTURE DELAY
Changes the interace mode setting. (0 : OFF, 1 : ON)



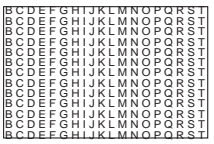

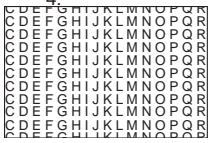

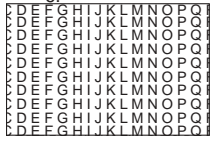

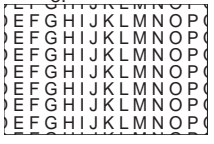

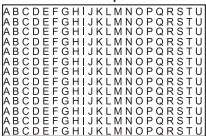
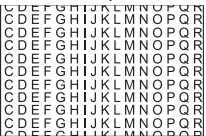
PIP

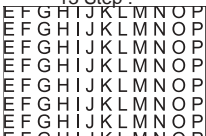

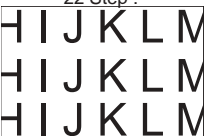
1. LAYOUT
Changes the OSD layout. (Single, PIP, PBP1, PBP2)
2. SOURCE
Changes the secondary source.
3. SIZE
Changes the PIP size(Small, Large).
4. POSITION
Changes the PIP Position..
5. SWAP
Swaps the position and size of the Primary and Secondary image.

Menus	Function Descriptions
BRIGHTNESS	Press the BRIGHTNESS button to display the ADJUST menu or UP,DOWN hot key. Setting the brightness too high or too low will decrease the amount of visible grayscales.
CONTRAST	Press the CONTRAST button to display the ADJUST menu or +,- hot key. Setting the Contrast too high or too low will cause loss of some grayscales.
CLOCK	Do not adjust. It will adjust automatically after auto adjustment. When frequency value is wrong, the horizontal image will have a wrong size or noise.
PHASE	Do not adjust. It will adjust automatically after auto adjustment. When frequency value is wrong, the image will have a noise.
BACKLIGHT	Adjusts backlight dimming level. Setting the backlight too low will cause dark image and too high will decrease the backlight life time.
AUTO ADJUST	Fits to the most appropriate screen on the D-SUB Analog/RGBS signal
SHARPNESS	Adjusts the sharpness of video image
SATURATION	Changes the tone of color
COLOR	Changes the richness of color(Range Greenish 0~50,Redish 0~50)
COLOR TEMP C1	Default 6500K color setting
COLOR TEMP C2	Default 9300K color setting
COLOR TEMP USER	Default 7200K color setting,but it's changeable value by user
IMAGE SIZE	<p>DSUB/ DVI OPTICAL / DVI DIGITAL input source</p> <p>FULL FILL ASPECT</p>  <p>1:1 NORMAL</p> <p>CAUTION : FILL ASPECT,NORMAL Size depends on input size ratio</p> <p>YPbPr / RGBS / SDI / CVIDEO / SVIDEO input source</p> <p>FULL FILL ASPECT 1:1</p> <p>NORMAL ANAMORPHIC</p> 

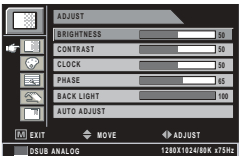
Menus	Function Descriptions
H POSITION	<p>Adjusts the Horizontal position of the image. It will return to the default state when executing AUTO ADJUST or RESET SETTINGS.</p> 
V POSITION	<p>Adjusts the Vertical position of the image. It will return to the default state when executing AUTO ADJUST or RESET SETTINGS.</p> 
GAMMA	<p>Adjusts the gamma curve of video image.</p> <div style="display: flex; justify-content: space-around; align-items: flex-start;"> <div style="text-align: center;"> <p>1.8</p>  </div> <div style="text-align: center;"> <p>2.0</p>  </div> <div style="text-align: center;"> <p>2.2</p>  </div> <div style="text-align: center;"> <p>2.4</p>  </div> <div style="text-align: center;"> <p>2.6</p>  </div> <div style="text-align: center;"> <p>PACS</p>  </div> <div style="text-align: center;"> <p>VIDEO</p>  </div> </div> <p>Note: BYPASS depends on panel gamma value, please refer to the panel specification.</p>
FILTER	<p>Adjusts the gamma curve of video image.</p> <div style="display: flex; align-items: center; justify-content: center;"> <div style="text-align: center;"> <p>SOFTEST</p>  </div> <div style="margin: 0 10px;">←</div> <div style="text-align: center;"> <p>SOFT</p>  </div> <div style="margin: 0 10px;">→</div> <div style="text-align: center;"> <p>NORMAL</p>  </div> <div style="margin: 0 10px;">→</div> <div style="text-align: center;"> <p>SHARP</p>  </div> <div style="margin: 0 10px;">→</div> <div style="text-align: center;"> <p>SHARPEST</p> </div> </div>
OVER SCAN	<p>Enables a 10% over scan of original input image.</p> <div style="display: grid; grid-template-columns: repeat(3, 1fr); gap: 10px;"> <div style="text-align: center;"> <p>0:</p>  </div> <div style="text-align: center;"> <p>1:</p>  </div> <div style="text-align: center;"> <p>2:</p>  </div> <div style="text-align: center;"> <p>3:</p>  </div> <div style="text-align: center;"> <p>4:</p>  </div> <div style="text-align: center;"> <p>5:</p>  </div> <div style="text-align: center;"> <p>6:</p>  </div> <div style="text-align: center;"> <p>7:</p>  </div> <div style="text-align: center;"> <p>8:</p>  </div> </div>

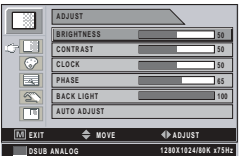
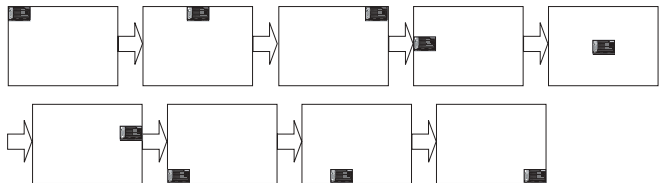
Menus	Function Descriptions
IMAGE SETTING	Saves 5 user's settings : BRIGHTNESS,CONTRAST,BACKLIGHT,COLOR,TEMP and FILTER separately.(PRESET1,2 / USER 1,2,3)
ZOOM / PAN	<p>Controls the zoom in/out of the image.</p> <p>0 Step :  4 Step :  9 Step : </p> <p>13 Step :  18 Step :  22 Step : </p> <p>26 Step :  30 Step : </p> <p>Controls the PAN in/out of the image.</p> 
FREEZE FRAME	Freezes the main image. Does not freeze secondary image in PIP mode.
LANGUAGE	Changes the OSD to one of 8 languages. ENGLISH / GERMAN / FRENCH / SPANISH / ITALIAN / JAPANESE / CHINESE / KOREAN
OSD COLOR	Adjusts the color of OSD.   
OSD POSITION	Adjusts the position of the OSD. 

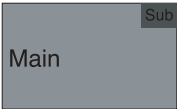
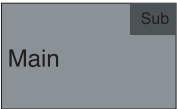
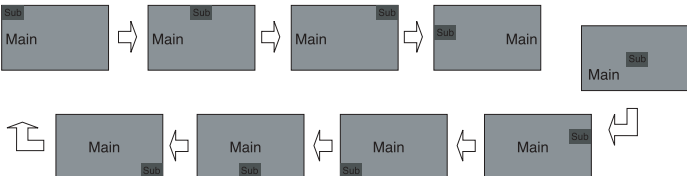
Menus	Function Descriptions																																																																																									
OSD DURATION	Adjusts the time the OSD menu remains on the screen.																																																																																									
RESET SETTING	Resets the monitor back to factory settings..																																																																																									
AUTO SOURCE SELECT	When AUTO SOURCE SELECT is on, the monitor will automatically search for an active MAIN input Source.																																																																																									
COLOR SPACE	Changes the input source between RGBs and YPbPr.																																																																																									
PIP LAY OUT	Sets on of four possible layouts(SINGLE,PIP,PBP1,PBP2) Note : The aspect ratio does not change in PIP or PBP1.																																																																																									
PIP SOURCE	Selects a PIP source input. You can change other sub windows through OSD pip menu. Below chart is PIP <table border="1" data-bbox="277 539 1081 938" style="margin: 10px auto;"> <thead> <tr> <th rowspan="2">Input source</th> <th colspan="8">Sub window</th> </tr> <tr> <th>DVI OPTICAL DVI DIGITAL 2</th> <th>DVI DIGITAL1</th> <th>DSUB ANALOG</th> <th>SDI</th> <th>YPbPr</th> <th>RGBS</th> <th>CVIDEO</th> <th>SVIDEO</th> </tr> </thead> <tbody> <tr> <td>DVI OPTICAL DVI DIGITAL 2</td> <td>X</td> <td>O</td> <td>O</td> <td>O</td> <td>O</td> <td>O</td> <td>O</td> <td>O</td> </tr> <tr> <td>DVI DIGITAL 1</td> <td>O</td> <td>X</td> <td>X</td> <td>O</td> <td>X</td> <td>X</td> <td>O</td> <td>O</td> </tr> <tr> <td>DSUB ANALOG</td> <td>O</td> <td>X</td> <td>X</td> <td>O¹</td> <td>X</td> <td>X</td> <td>O</td> <td>O</td> </tr> <tr> <td>SDI</td> <td>O</td> <td>O</td> <td>O¹</td> <td>X</td> <td>O¹</td> <td>O¹</td> <td>X</td> <td>X</td> </tr> <tr> <td>YPbPr</td> <td>O</td> <td>X</td> <td>X</td> <td>O¹</td> <td>X</td> <td>X</td> <td>O</td> <td>O</td> </tr> <tr> <td>RGBS</td> <td>O</td> <td>X</td> <td>X</td> <td>O¹</td> <td>X</td> <td>X</td> <td>O</td> <td>O</td> </tr> <tr> <td>CVIDEO</td> <td>O</td> <td>O</td> <td>O</td> <td>X</td> <td>O</td> <td>O</td> <td>X</td> <td>X</td> </tr> <tr> <td>SVIDEO</td> <td>O</td> <td>O</td> <td>O</td> <td>X</td> <td>O</td> <td>O</td> <td>X</td> <td>X</td> </tr> </tbody> </table> <p data-bbox="258 951 829 975">O¹ : Support up to UXGA,60Hz (162MHz) : Option to have DVI 2</p>	Input source	Sub window								DVI OPTICAL DVI DIGITAL 2	DVI DIGITAL1	DSUB ANALOG	SDI	YPbPr	RGBS	CVIDEO	SVIDEO	DVI OPTICAL DVI DIGITAL 2	X	O	O	O	O	O	O	O	DVI DIGITAL 1	O	X	X	O	X	X	O	O	DSUB ANALOG	O	X	X	O ¹	X	X	O	O	SDI	O	O	O ¹	X	O ¹	O ¹	X	X	YPbPr	O	X	X	O ¹	X	X	O	O	RGBS	O	X	X	O ¹	X	X	O	O	CVIDEO	O	O	O	X	O	O	X	X	SVIDEO	O	O	O	X	O	O	X	X
Input source	Sub window																																																																																									
	DVI OPTICAL DVI DIGITAL 2	DVI DIGITAL1	DSUB ANALOG	SDI	YPbPr	RGBS	CVIDEO	SVIDEO																																																																																		
DVI OPTICAL DVI DIGITAL 2	X	O	O	O	O	O	O	O																																																																																		
DVI DIGITAL 1	O	X	X	O	X	X	O	O																																																																																		
DSUB ANALOG	O	X	X	O ¹	X	X	O	O																																																																																		
SDI	O	O	O ¹	X	O ¹	O ¹	X	X																																																																																		
YPbPr	O	X	X	O ¹	X	X	O	O																																																																																		
RGBS	O	X	X	O ¹	X	X	O	O																																																																																		
CVIDEO	O	O	O	X	O	O	X	X																																																																																		
SVIDEO	O	O	O	X	O	O	X	X																																																																																		
PIP SIZE	Changes PIP mode sub window size <div style="display: flex; justify-content: space-around; align-items: center; margin-top: 10px;"> <div style="text-align: center;"> <p>SMALL</p>  <p>25% / Panel size</p> </div> <div style="text-align: center;"> <p>LARGE</p>  <p>33% / Panel size</p> </div> </div>																																																																																									
PIP POSITION	Changes PIP mode sub window Position <div style="text-align: center; margin-top: 10px;">  </div>																																																																																									

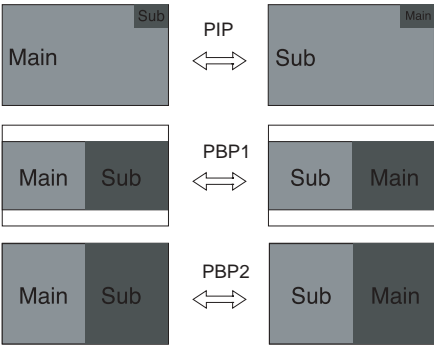
Menus	Function Descriptions
SWAP	<p>Changes main window and sub window position in PIP,PBP1,PBP2.</p>  <p>The diagram illustrates three window swapping functions:</p> <ul style="list-style-type: none"> PIP: Shows a 'Main' window with a 'Sub' window in the top-right corner. A double-headed arrow points to a 'Sub' window with a 'Main' window in the top-right corner. PBP1: Shows a 'Main' window with a 'Sub' window on the right side. A double-headed arrow points to a 'Sub' window with a 'Main' window on the right side. PBP2: Shows a 'Main' window with a 'Sub' window on the right side. A double-headed arrow points to a 'Sub' window with a 'Main' window on the right side.

Standard Signal table

▶ PC Supported Mode

Resolution	Horizontal Frequency (KHz)	Vertical Frequency (Hz)	Clock Frequency (MHz)	
640 X 350 @70Hz	31.50	70.00	25.17	<div style="display: flex; justify-content: space-around; align-items: center;"> <div style="text-align: center;"> $FS-L190^*D(T)$ </div> <div style="text-align: center;"> $FS-L260^*D / FS-P260^*D / FS-L320^*D / FS-L420^*D / FS-L550^*D$ </div> <div style="text-align: center;"> $FS-L240^*D(T) / FS-L260^*D$ </div> </div>
720 X 400 @70Hz	31.50	70.00	28.32	
640 X 480 @60Hz	31.50	60.00	25.18	
640 X 480 @75Hz	37.50	75.00	31.50	
800 X 600 @60Hz	37.90	60.00	40.00	
800 X 600 @75Hz	46.90	75.00	49.50	
1024 X 768 @60Hz	48.40	60.00	65.00	
1024 X 768 @75Hz	60.00	75.00	78.75	
1152 X 864 @60Hz	54.35	60.00	80.000	
1152 X 864 @75Hz	67.50	75.00	108.00	
1280 X 720 @60Hz	44.70	60.00	74.40	
1280 X 1024@60Hz	64.00	60.00	108.00	
1280 X 1024@75Hz	80.00	75.00	135.00	
1360 X 768@75Hz	47.70	60.00	108.75	
1600 X 1200@60Hz	75.00	60.00	162.00	
1920 X 1080@60Hz	67.50	60.00	148.50	
1920 X 1200@60Hz	74.00	60.00	154.12	

▶ SDI Video format

Output Signal	Description
SMPTE-424M	1080p (3G)
SMPTE-292M	720p , 1080i (HD)
SMPTE-259M	480i , 576i (SD)

Signal connector Pin Assignments

VGA (15Pin D-SUB)

Pin No.	Assignment	Pin No.	Assignment
1	Red	9	No Connection
2	Green	10	Ground-Sync
3	Blue	11	Ground
4	Ground	12	DDC Data
5	DDC 5V Standby	13	H.Sync
	Cable Connection check	14	V.Sync
6	Ground-Red	15	DDC Clock
7	Ground-Green		
8	Ground-Blue		

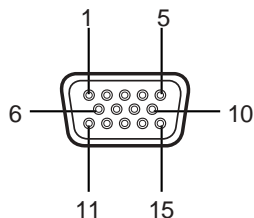

DVI In,Out (24Pin DVI-D)

Pin No.	Assignment	Pin No.	Assignment
1	T.M.D.S. Data2-	13	No Connection
2	T.M.D.S. Data2+	14	+5V Power
3	T.M.D.S. Data2 Shield	15	Ground
4	No Connection	16	Hot Plug Detect
5	No Connection	17	T.M.D.S. Data0-
6	DDC Clock	18	T.M.D.S. Data0+
7	DDC Data	19	T.M.D.S. Data0 Shield
8	No Connection	20	No Connection
9	T.M.D.S. Data1-	21	No Connection
10	T.M.D.S. Data1+	22	T.M.D.S. Clock Shield
11	T.M.D.S. Data1 Shield	23	T.M.D.S. Clock+
12	No Connection	24	T.M.D.S. Clock-

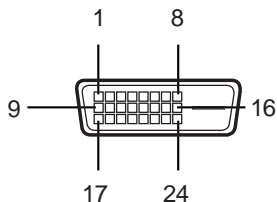

C-Video (BNC)

Pin No.	Assignment
1	Composite
2	Ground

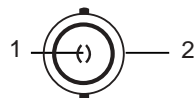

▶ S-Video (BNC)

Pin No.	Assignment
1	S-VIDEO/Y (Luma)
2	S-VIDEO/C (Chroma)
3	Ground

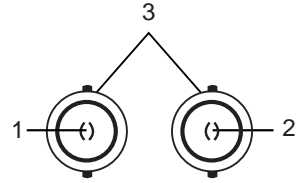

▶ RS232C (D-SUB 9Pin)

Pin No.	Assignment
1	No Connection
2	TXD
3	RXD
4	No Connection
5	Ground
6	No Connection
7	No Connection
8	No Connection
9	No Connection

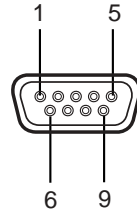

▶ SDI (BNC)

Pin No.	Assignment
1	SDI IN
2	SDI OUT
3	Ground

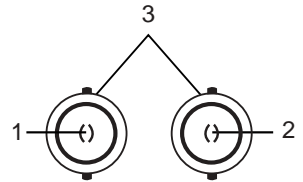

▶ GPIO

Pin No.	Assignment
1	P,S Swap
2	PIP,PBP1,PBP2 Select
3	Record Indicator
4	Ground



RGBHV/RGBS/YPbPr (BNC)

Pin No.	Assignment	
	RGBS	Y Pb Pr
1	Red	Pr
2	Green	Y
3	Blue	Pb
4	H-Sync / C-Sync	No Connection
5	V-Sync	No Connection
6	Ground	

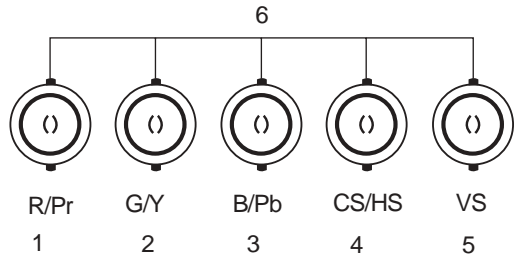

OPTICAL , LC Type (Matched with DDL receivers)

Pin No.	Assignment
1	OPTICAL Clock
2	OPTICAL Blue
3	OPTICAL Green
4	OPTICAL Red

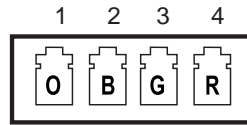

OPTICAL , SC Type (Matched with DDL receivers)

Pin No.	Assignment
1	OPTICAL IN



OPTICAL , LC Type (Matched with DOL receivers)

Pin No.	Assignment
1	OPTICAL IN



Specification

FS-L190*D / FS-L190*DT

Model		FS-L190*D / FS-L190*DT
Optical Characteristics	Type	19" TFT-LCD
	Screen Size	19 inch(5:4)
	Maximum Resolution	1280 X 1024 @ 60Hz
	Pixel Pitch	0.294(H) mm X 0.294(V) mm
	Display Colors	16.7M
	Contrast Ratio(Typical)	800:1
	Viewing Angle	85° / 85° / 85° / 85°
	Response Time	14 msec(Gray to Gray)
	Luminance(Typical)	270cd/m ²
Touch Specification (F-L190*DT only)	Touch Panel	ELO 5wire resistive touch screen
	Interface	USB & SERIAL
Front Filter (FS-L190*D only)	Acrylic	Double side Anti-Reflection coating
Resolution	Signal input	VGA~SXGA
Power	Maximum	Max 60W
	Standby Mode	Max 20W
Control Key	Front Side	INPUT, -, +, ▼, ▲, PIP, MENU, POWER
Input Signal	Video	1xDVI, 1x Optical DVI 1(DVI 2 option), 1x D-SUB, 1xBNC (CVBS)Video, 2 x BNC (SVHS Y/C), 1 x BNC(SD/HD/3G-SDI), 5 x BNC (Component Y/G, Pb/B, Pr/R, H/CS, VS)
Output Signal	Video	1xDVI, 1xBNC (SD/HD/3G-SDI)
Input Power	DC 12V, 7A Max	
Dimension	Size and Weight	423(W)X351.5(H)X76.5(D) (mm) 7.3Kg -Without stand 16.653(W)X13.838(H)X3.011(D) (inch) 16.09lbs-Without stand

FS-L240*D / FS-L240*DT

MODEL		FS-L240*D / FS-L240*DT
Optical Characteristics	Type	24" TFT-LCD
	Screen Size	24 inch(16:10)
	Maximum Resolution	1920 X 1200 @ 60Hz
	Pixel Pitch	0.270(H) mm X 0.270(V) mm
	Display Colors	1.06Billion
	Contrast Ratio(Typical)	1000:1
	Viewing Angle	89° / 89° / 89° / 89°
	Response Time	6 msec(Rising+Falling)
	Luminance(Typical)	400cd/m ²
Touch Specification (F-L240*DT only)	Touch Panel	ELO 5wire resistive touch screen
	Interface	USB & SERIAL
Front Filter (FS-L240*D only)	Acrylic	Double side Anti-Reflection coating
Resolution	Signal input	VGA~WUXGA
Power	Maximum	Max 100W
	Standby Mode	Max 20W
Control Key	Front Side	INPUT, -, +, ▼, ▲, PIP, MENU, POWER
Input Signal	Video	1xDVI, 1x Optical DVI 1(DVI 2 option), 1x D-SUB, 1xBNC (CVBS)Video, 2 x BNC (SVHS Y/C), 1 x BNC(SD/HD/3G-SDI), 5 x BNC (Component Y/G, Pb/B, Pr/R, H/CS, VS)
Output Signal	Video	1xDVI, 1xBNC (SD/HD/3G-SDI)
Input Power	DC 24V, 6.25A Max	
Dimension	Size and Weight	580(W)X386(H)X95(D) (mm) 7.5Kg -Without stand 22.834(W)X15.196(H)X3.740(D) (inch) 16.53lbs-Without stand

MODEL		FS-L260*D
Optical Characteristics	Type	26" TFT-LCD
	Screen Size	26 inch(16:10)
	Maximum Resolution	1920X 1200 @ 60Hz
	Pixel Pitch	0.2685(H) mm X 0.2685(V) mm
	Display Colors	16.7M
	Contrast Ratio(Typical)	1000:1
	Viewing Angle	89° / 89° / 89° / 89°
	Response Time	6 msec(Rising+Falling)
	Luminance(Typical)	400cd/m ²
Resolution	Video input	VGA~WUXGA
Front Filter	Acrylic	Double side Anti-Reflection coating
Power	Maximum	Max 130W
	Standby Mode	Max 20W
Control Key	Front Side	INPUT, -, +, ▼, ▲, PIP, MENU, POWER
Input Signal	Video	1xDVI, 1x Optical DVI 1(DVI 2 option), 1x D-SUB, 1xBNC (CVBS)Video, 2 x BNC (SVHS Y/C), 1 x BNC(SD/HD/3G-SDI), 5 x BNC (Component Y/G, Pb/B, Pr/R, H/CS, VS)
Output Signal	Video	1xDVI, 1xBNC (SD/HD/3G-SDI)
Input Power	DC 24V, 6.25A Max	
Dimension	Size and Weight	618(W)X412(H)X99.5(D) (mm) 8.8Kg -Without stand 24.330(W)X16.220(H)X3.917(D) (inch) 19.4lbs -Without stand

FS-L260*D(LED)

MODEL		FS-L260*D(LED)
Optical Characteristics	Type	26" TFT-LCD
	Screen Size	26 inch(16:9)
	Maximum Resolution	1920X 1080 @ 60Hz
	Pixel Pitch	0.3(H) mm X 0.3(V) mm
	Display Colors	16.7M
	Contrast Ratio(Typical)	1000:1
	Viewing Angle	89° / 89° / 89° / 89°
	Response Time	6 msec(Rising+Falling)
	Luminance(Typical)	350cd/m ²
Resolution	Video input	VGA~1080p
Front Filter	Acrylic	Double side Anti-Reflection coating
Power	Maximum	Max 70W
	Standby Mode	Max 20W
Control Key	Front Side	INPUT, -, +, ▼, ▲, PIP, MENU, POWER
Input Signal	Video	1xDVI, 1x Optical DVI 1(DVI 2 option), 1x D-SUB, 1xBNC (CVBS)Video, 2 x BNC (SVHS Y/C), 1 x BNC(SD/HD/3G-SDI), 5 x BNC (Component Y/G, Pb/B, Pr/R, H/CS, VS)
Output Signal	Video	1xDVI, 1xBNC (SD/HD/3G-SDI)
Input Power	DC 24V, 6.25A Max	
Dimension	Size and Weight	638(W)X389(H)X74.7(D) (mm) 7.3Kg -Without stand 25.118(W)X15.315(H)X2.941(D) (inch) 16.1lbs-Without stand

FS-P260*D(LED)

MODEL		FS-P260*D(LED)
Optical Characteristics	Type	26" TFT-LCD
	Screen Size	26 inch(16:9)
	Maximum Resolution	1920X 1080 @ 60Hz
	Pixel Pitch	0.3(H) mm X 0.3(V) mm
	Display Colors	1.06B
	Contrast Ratio(Typical)	1400:1
	Viewing Angle	89° / 89° / 89° / 89°
	Response Time	8 msec(Rising+Falling)
	Luminance(Typical)	450cd/m ²
Resolution	Video input	VGA~1080p
Front Filter	Acrylic	Double side Anti-Reflection coating
	Touch(Optional)	26" IR Multi Touch(USB)
	Glass(Optional)	Optical bonding
Power	Maximum	Max 70W
	Standby Mode	Max 20W
Control Key	Front Side	INPUT, -, +, ▼, ▲, PIP, MENU, POWER
Input Signal	Video	1xDVI, 1x Optical DVI 1(DVI 2 option), 1x D-SUB, 1xBNC (CVBS)Video, 2 x BNC (SVHS Y/C), 1 x BNC(SD/HD/3G-SDI), 5 x BNC (Component Y/G, Pb/B, Pr/R, H/CS, VS)
Output Signal	Video	1xDVI, 1xBNC (SD/HD/3G-SDI)
Input Power	DC 24V, 6.25A Max	
Dimension	Size and Weight	638(W)X389(H)X74.7(D) (mm) 7.6Kg -Without stand 25.118(W)X15.315(H)X2.941(D) (inch) 16.76lbs -Without stand

FS-L320*D

MODEL		FS-L320*D
Optical Characteristics	Type	32" TFT-LCD
	Screen Size	32 inch(16:9)
	Maximum Resolution	1920X 1080 @ 60Hz
	Pixel Pitch	0.363(H) mm X 0.363(V) mm
	Display Colors	1.06 billion
	Contrast Ratio(Typical)	1300:1
	Viewing Angle	89° / 89° / 89° / 89°
	Response Time	6msec(Rising+Falling)
	Luminance(Typical)	500cd/m ²
Resolution	Video input	VGA~1080P
Front Filter	Glass	Double side Anti-Reflection coating
Power	Maximum	Max 150W
	Standby Mode	Max 20W
Control Key	Front Side	INPUT, -, +, ▼, ▲, PIP, MENU, POWER
Input Signal	Video	1xDVI, 1xOptical DVI 1(DVI 2 option), 1x D-SUB, 1xBNC (CVBS)Video, 2 x BNC (SVHS Y/C), 1 x BNC(SD/HD/3G-SD), 5 x BNC (Component Y/G, Pb/B, Pr/R, H/CS, VS)
Output Signal	Video	1xDVI, 1xBNC (SD/HD/3G-SDI)
Input Power	DC 24V, 7.5A Max	
Dimension	Size and Weight	795(W)X485(H)X100(D) (mm) 15.8Kg -Without stand 31.299(W)X19.094(H)X3.937(D) (inch) 34.8lbs-Without stand

FS-L420*D

MODEL		FS-L420*D
Optical Characteristics	Type	42" TFT-LCD
	Screen Size	42 inch(16:9)
	Maximum Resolution	1920X 1080 @ 60Hz
	Pixel Pitch	0.4845(H) mm X 0.4845(V) mm
	Display Colors	1.06 billion
	Contrast Ratio(Typical)	1300:1
	Viewing Angle	89° / 89° / 89° / 89°
	Response Time	6 msec(Rising+Falling)
	Luminance(Typical)	500cd/m ²
Resolution	Video input	VGA~1080P
Front Filter	Glass	Double side Anti-Reflection coating
Power	Maximum	Max 260W
	Standby Mode	Max 20W
Control Key	Front Side	INPUT, -, +, ▼, ▲, PIP, MENU, POWER
Input Signal	Video	1xDVI, 1xOptical DVI 1(DVI 2 option), 1xD-SUB, 1xBNC (CVBS)Video, 2x BNC (SVHS Y/C), 1 x BNC(SD/HD/3G-SDI), 5 x BNC (Component Y/G, Pb/B, Pr/R, H/CS, VS)
Output Signal	Video	1xDVI, 1xBNC (SD/HD/3G-SDI)
Input Power	AC 100~230V, 50~60Hz,3A Max	
Dimension	Size and Weight	1024.6(W)X617.4(H)X111.1(D) (mm) 28Kg -Without stand 40.338(W)X24.307(H)X4.374(D) (inch) 61.7lbs-Without stand

FS-L550*D

MODEL		FS-L550*D
Optical Characteristics	Type	55" TFT-LCD
	Screen Size	55 inch(16:9)
	Maximum Resolution	1920X 1080 @ 60Hz
	Pixel Pitch	0.630(H) mm X 0.630(V) mm
	Display Colors	1.06 billion
	Contrast Ratio(Typical)	1300:1
	Viewing Angle	89° / 89° / 89° / 89°
	Response Time	6 msec(Rising+Falling)
	Luminance(Typical)	450cd/m ²
Resolution	Video input	VGA~1080P
Front Filter	Glass	Double side Anti-Reflection coating
Power	Maximum	Max 200W
	Standby Mode	Max 20W
Control Key	Front Side	INPUT, -, +, ▼, ▲, PIP, MENU, POWER
Input Signal	Video	1xDVI, 1xOptical DVI 1(DVI 2 option), 1xD-SUB, 1xBNC (CVBS)Video, 2x BNC (SVHS Y/C), 1 x BNC(SD/HD/3G-SDI), 5 x BNC (Component Y/G, Pb/B, Pr/R, H/CS, VS)
Output Signal	Video	1xDVI, 1xBNC (SD/HD/3G-SDI)
Input Power	AC 100~230V, 50~60Hz,3A Max	
Dimension	Size and Weight	1293.0(W)X777.0(H)X86.3(D) (mm) 37Kg -Without stand 50.91(W)X30.59(H)X3.4(D) (inch) 81.57lbs-Without stand

Cleaning Instructions

Precautions

- Before cleaning, switch the display in stand-by position to prevent the control touch panel from being activated inadvertently by sweeping over the front filter. In stand-by position the touch panel cannot be activated by just sweeping over them. To switch the display on again, you must press the stand-by key again.
- Take care not to damage or scratch the front filter or LCD panel.
- Be careful with rings or other jewellery that can touch the front filter.
- Do not apply pressure on the front filter or LCD panel.
- Do not apply or spray liquid directly to the front filter, panel or cabinet as excess liquid may cause damage to internal electronics. Instead, apply the liquid to the cleaning cloth.
- Follow your hospital protocol for the handling of blood and body fluids.
- The display is not disinfected or packed in sterile environment.
- Follow your hospital protocol in case the display needs to be disinfected prior to installation.

Front Filter

Proceed as follows:

1. Remove dust with a dry, lint-free, non-abrasive soft cotton cloth.
2. Remove fingerprints or grease using a lint-free, non-abrasive soft cotton cloth that is lightly moistened with plain water or a mild commercial glass cleaning product suited for coated glass surfaces.
3. Gently wipe dry with a dry cloth.

The following products are tested and approved:

- Misty Clear Lemon 10 Disinfectant
- Bohle glass cleaner
- Zep Heavy-duty glass & all surface cleaner

- Klear Screen
- Screen TFT (Kontakt Chemie)
- Incidin Foam (Ecolab)
- Microzid
- Mild detergent
- Isopropyl alcohol with concentration < 5%
- Household bleach (generic sodium hypochlorite, solutions of 5.25% sodium hypochlorite diluted with water between 1:10 and 1:100)

Do NOT use:

- Alcohol/solvents at higher concentration > 5%
- Strong alkalis, strong solvents
- Acid
- Detergents with fluoride
- Detergents with ammonia
- Detergents with abrasives
- Steel wool
- Sponge with abrasives
- Steel blades
- Cloth with steel thread

Cabinet

Proceed as follows:

- Clean the cabinet using a soft cotton cloth, lightly moistened with a recognized cleaning product for medical equipment.
- Repeat with water only.
- Wipe dry with a dry cloth.
- The cabinet has been tested for resistance to the following products:
 - Virex Ready-to-use Disinfectant Cleaner
 - Misty Clear Lemon 10 Disinfectant
 - Misty Multi-Purpose Disinfectant Cleaner
 - Misty Multi-Purpose Disinfectant Cleaner II

- Zep Heavy-duty glass & all surface cleaner
- Klear Screen
- Screen TFT (Kontakt Chemie)
- Incidin Foam (Ecolab)
- Microzid
- Mild detergent
- Isopropyl alcohol with concentration < 5%
- Household bleach (generic sodium hypochlorite, solutions of 5.25% sodium hypochlorite diluted with water between 1:10 and 1:100)
- Precise Hospital Foam Cleaner Disinfectant

DVI ② (Fiber) install guide (Rx)

Pull out the DVI ② slot gendr by loosening 2 screws on the bracket

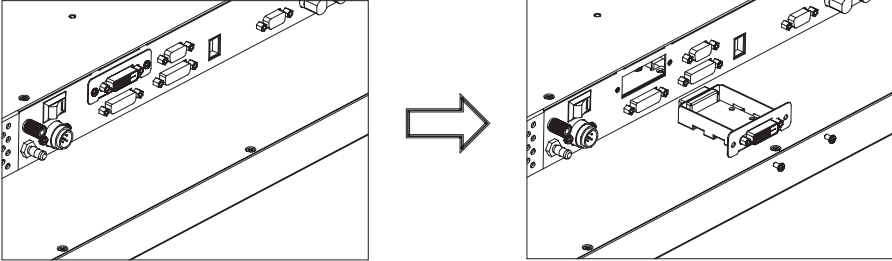

DDL(4ch LC) Rx installation

Insert DDL Rx into blank DVI2 slot and fasten it by 2 screws with DDL bracket.

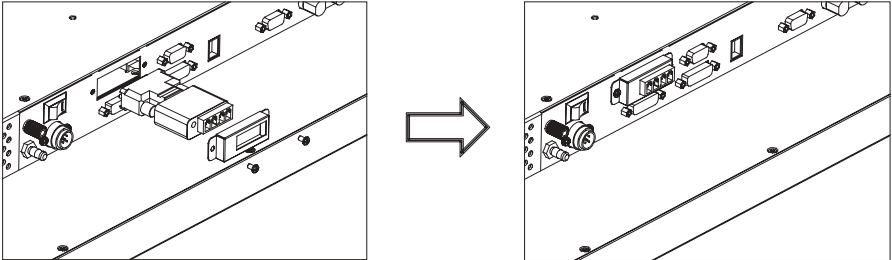

DDL(1ch LC) Rx installation

Insert DOL Rx into blank DVI2 slot and fasten it by 2 screws with DOL bracket.

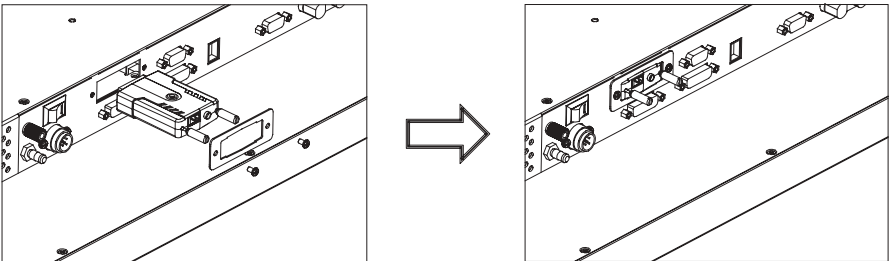

DSP/DSK (1ch SC) Rx installation

Insert DSP Rx into blank DVI2 slot and fasten it by 2 screws with DSP/DSK bracket.

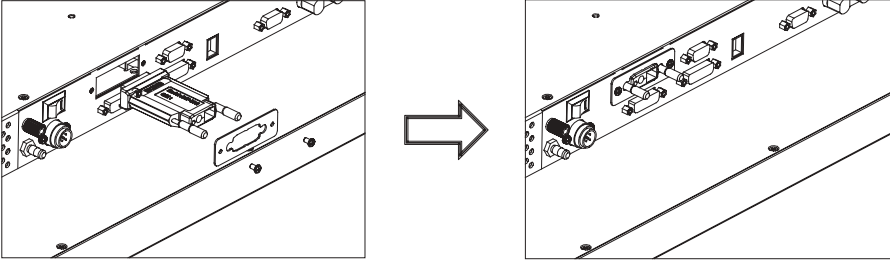



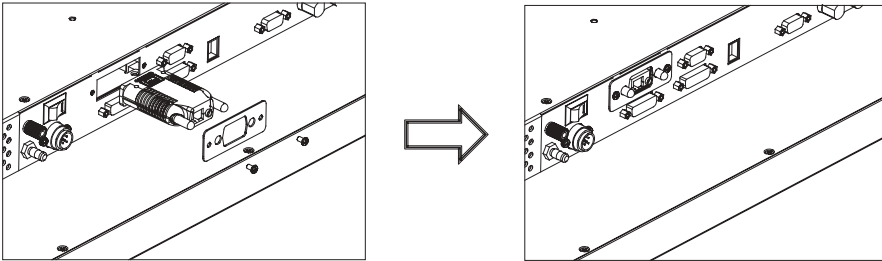

DSL (1ch SC) Rx installation

Insert DSL Rx into blank DVI2 slot and fasten it by 2 screws with DSL bracket.



Please place an order to provider to get each bracket for fiber extenders

Fiber extender	Order code	Drawing	Application models
DDL	639494070400		FS-L240*D FS-L260*D
DOL	639494083000		FS-P260*D FS-L320*D
DSP/DSK	639494070300		FS-L420*D FS-L550*D
DSL	639494083100		(*means numeric depend on customer)

Thank you for choosing our product.

Service

Please contact our customer service if you need any information or help with our products.

Warranty

One year, parts and labor

ASIA

FORESEESON KOREA

Room404-b, PangyolInnovalley B, Sampyeong-Dong621, Bundang-gu,
Seongnam-si, Gyeonggi-do, Korea
Tel.+82(31)8018-0780 Fax. +82(31)8018-0786
www.fsnmed.com

USA

FORESEESON CUSTOM DISPLAY INC

2210 E. Winston Road, Anaheim, CA 92806 USA
Tel.1-714-300-0540 Fax. 1-714-300-0546

EC Representative

FORESEESON GmbH

Industriestrasse 18a, 63150 Heusenstamm, Germany
Tel.+49(0)6104-643980

FORESEESON UK

Unit 2, Kingsmill Business Park
Chapel Mill Road, Kingston upon Thames, Surrey
KT1 3GZ, UK
Tel.+44-(0)208-546-1047



D&T Inc.
Jang-dong, Daedeok Valley, 26-121, Gajeongbuk-ro,
Yuseong-gu, Daejeon, Korea
Tel : 82-2-360-8000 Fax. +82(2)360-8005

